

MERITOR® PADS & ROTORS

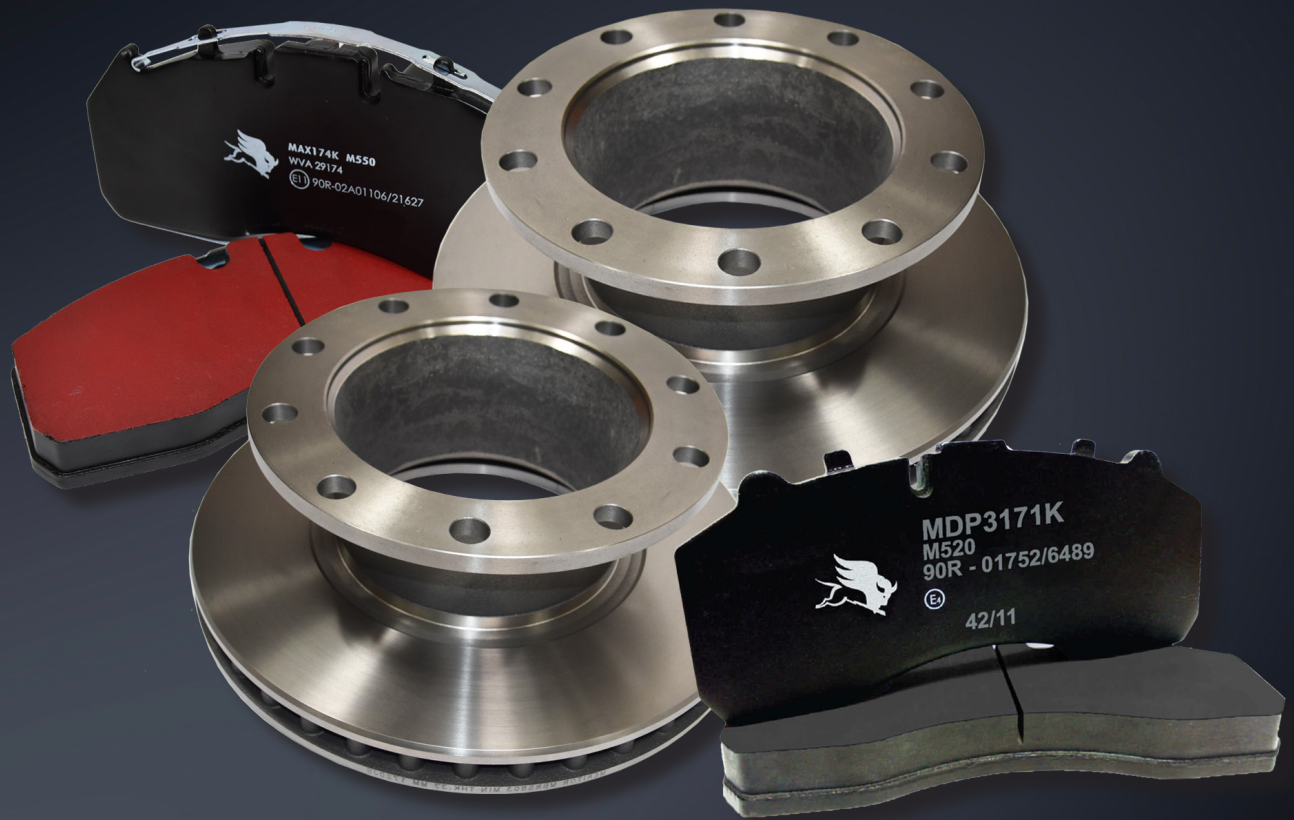

IMPORTANT INFORMATION

AFTERMARKET PARTS WARRANTY

We warrant all new parts for one year from date of shipment to the buyer against defective material or workmanship (but not against damage caused by accident, abuse or improper installation, maintenance or repair) when such parts are used on vehicles the specifications of which have been approved by our Engineering Department.

As the exclusive remedy under this warranty, we will, at our option, repair or replace such parts free of charge, or take back the nonconforming parts and refund the monies paid by buyer for such parts, if found on examination by us to be nonconforming and if necessary return charges are prepaid.

If it is necessary to return any parts under this warranty, buyer agrees not to make any deduction on account thereof from remittances on current accounts while claims are in the process of disposition. Any expense incurred without our consent for repairs or replacement will not be allowed.

THIS WARRANTY IS EXPRESSLY IN LIEU OF ALL OTHER WARRANTIES OR CONDITIONS, EXPRESS, IMPLIED OR STATUTORY, INCLUDING ANY IMPLIED WARRANTY OF MERCHANTABILITY OR FITNESS FOR PARTICULAR PURPOSE. IN NO EVENT SHALL SELLER BE LIABLE FOR INCIDENTAL OR CONSEQUENTIAL DAMAGES OF ANY NATURE.

Only genuine Meritor replacement parts are covered by this aftermarket parts warranty.

DISCLAIMER

Information contained in this publication is in effect at the time the publication was approved for printing and is subject to change without notice or liability. Meritor, reserves the right to revise the information presented or discontinue the production of parts described at any time.

Manufacturers names, part numbers, symbols or other references appearing in this catalogue are used for reference for order of goods only. Images are also for reference only and not to scale.

TRADEMARK

The designated trademarks are registered marks of their respective owners and Meritor and its affiliates are not commercially connected, affiliated, or associated with any of the owners of such marks. The Meritor products presented herein are not endorsed or authorised by any of the trademark owners.

COPYRIGHT

All rights reserved. The Meritor or any part or layout of the catalogue cannot be printed or reproduced without written authorisation from Meritor.



Found an error?

If you detect any errors in this catalogue, please let us know. We want to ensure the information we publish is as accurate as possible. We appreciate your help in making this happen.









Please forward your enquiries to:
Email: cvaau.sales@meritor.com
Phone: (03) 8353 6050

TABLE OF CONTENTS

MERITOR® PADS & ROTORS

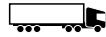
- Important Information 2
- Table of Contents 3
- MDP Series:
 - Product Information 4
 - Features 5
 - Testing 6
 - Comparison 7
- MAX Series (Premium):
 - Product Information 8
 - Features 9
 - Testing 10
 - Range 11
- Application Reference 12
- MDP3000 Range 23
- Meritor Calipers 34
- MAX Range 35
- Cross References:
 - Cross Reference to Meritor Brake Pads 37
 - Cross Reference to Meritor Brake Rotors 45
 - Brake Pads & Rotors Pairing Guide 49

Glossary:

	Axle		Caliper Make		Date Range		Pad
	Length		Truck / Trailer		Front		Original Equipment / Part
	Height		Bus		Rear		
	Thickness		LCV		Rotor		

 MAKE & MODEL DESCRIPTION			ROTOR 				PAD 			
			Part #	Dia	W	Ht	H	Part #	L	H

Dia - Diameter
 W - Width
 Ht - Height
 H - Holes

L - Length
 H - Height
 W - Width

MDP SERIES PRODUCT INFORMATION

Meritor MDP Series Brake Pads

The MDP series brake pads from Meritor set high standards in commercial vehicle aftermarket disc brake pads. The brake pads featuring M520 friction material are manufactured to the highest standards in a TS-16949 accredited state-of-the-art Meritor approved facility. With pads to fit the most popular European truck, bus and trailer applications the MDP series come complete with fitting kits (where applicable).



New Identity

With its own new brown box and part numbering sequence the MDP series can be perfectly differentiated from the MDP5000 series of Original Equipment brake pads. The “brown” image is the new colour of quality for aftermarket brake pads.

New Performance

Not only does the exclusive Meritor M520 friction material featured on the MDP3000 series of brake pads fall within the +/-15% performance requirement for UNECE R90 it also delivers pad and disc wear rates that are close to OE standards. In addition the performance characteristics of M520 are superior to the majority of aftermarket friction materials. As you would expect every pad is UNECE R90 approved but more than that Meritor have tested the pads in many additional aspects than the minimum requirement to achieve UNECE R90.

R90 Performance Graph

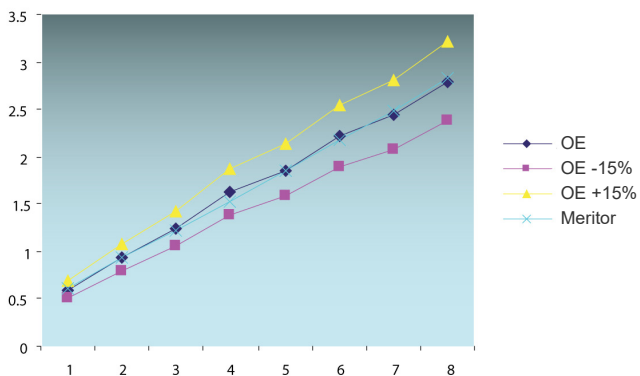

MDP SERIES FEATURES

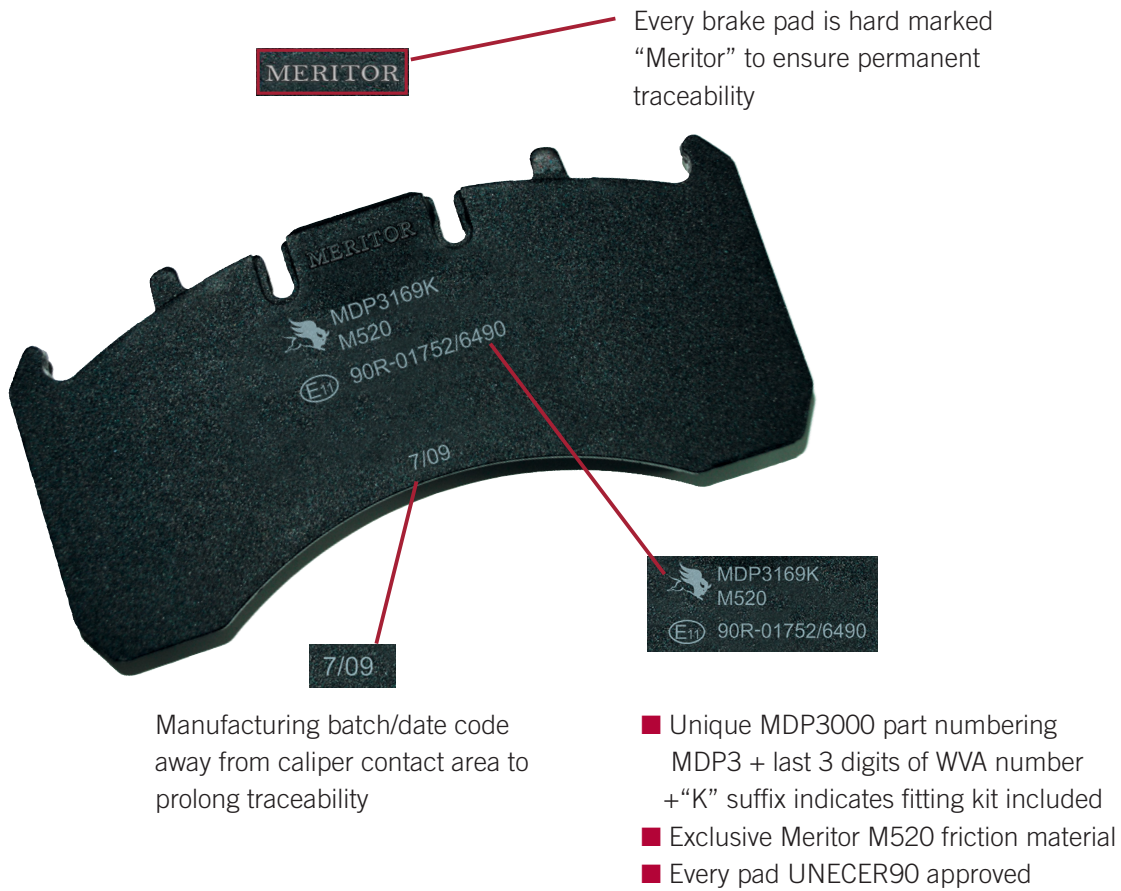

Manufacturing batch/date code away from caliper contact area to prolong traceability

- Unique MDP3000 part numbering
MDP3 + last 3 digits of WVA number
+ "K" suffix indicates fitting kit included
- Exclusive Meritor M520 friction material
- Every pad UNECE90 approved

SPECIALLY DEVELOPED INITIAL PERFORMANCE COATING

- Provides optimum initial braking performance
- Accelerated bedding & conditioning process
- Cleans brake disc surface

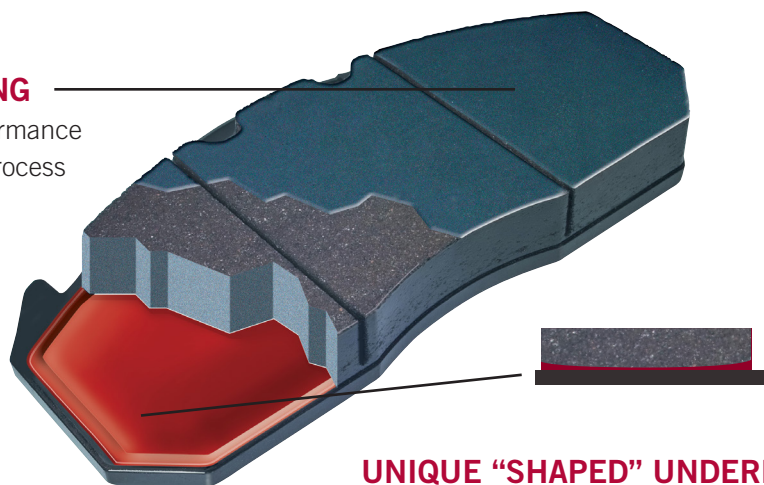

UNIQUE "SHAPED" UNDERLAYER

- Improved thermal efficiency
- Increased hot & cold shear strength
- Reduced risk of edge separation

MDP SERIES TESTING

Testing

Through a combination of internal and independent external testing, conducted in accordance with the ISO15484 protocol and other industry recognised test schedules, a number of aftermarket brake pad materials were evaluated alongside a market leading Original Equipment friction material.

Using the Original Equipment friction material as a benchmark the Meritor M520 material and seven other aftermarket brake pads were tested to extremes of speed, temperature, pressure and deceleration.

Brake pad quality is a question of balance and compromise between brake pad wear, brake disc wear and consistent predictable performance.

During the extensive testing the Meritor M520 friction material consistently delivered similar levels of brake performance, pad wear and disc wear to the benchmark OE material.

Below are the results of these tests for M520 and six main competitors' materials in terms of brake performance, brake pad wear and brake disc wear.

Often brake pad suppliers claim to deliver "better than OE" brake pad wear but from the test results you will see that although some of the competitor's pads deliver excellent pad wear it is usually at the expense of disc wear and/or brake performance.



The majority of the wear and performance evaluation was carried out independently and impartially by Brake Testing International Ltd UK on behalf of Meritor CVA Europe.

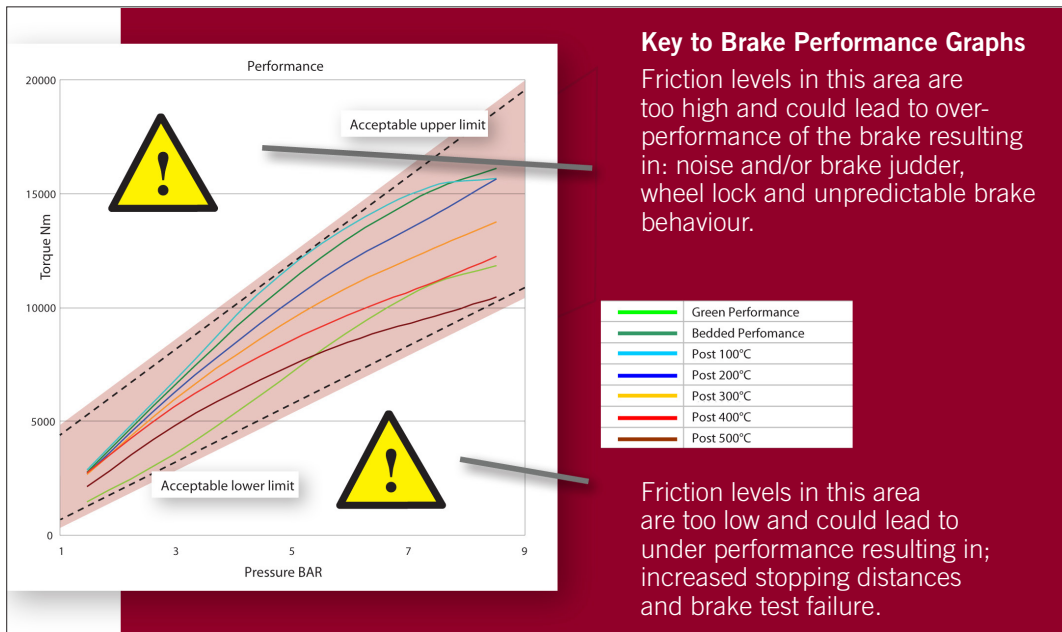

Competitor G

The seventh set of pads were of such poor quality that they didn't even make it to the end of the wear test.

REJECTED



MDP SERIES VS ORIGINAL EQUIPMENT

Throughout the tests the M520 friction material as used exclusively on the MDP series of brake pads consistently delivered comparable brake pad wear, brake disc wear and brake performance to the OE material even at temperatures in excess of 500°C.

Meritor MDP series delivers pad wear within 12% of the OE

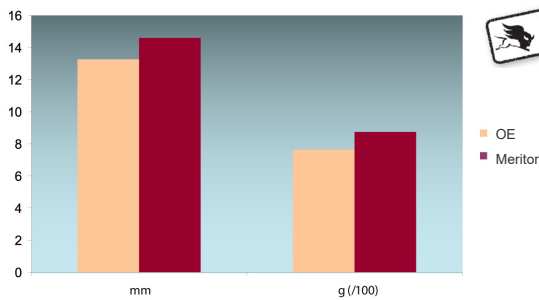

Meritor MDP series delivers better brake disc wear than the OE

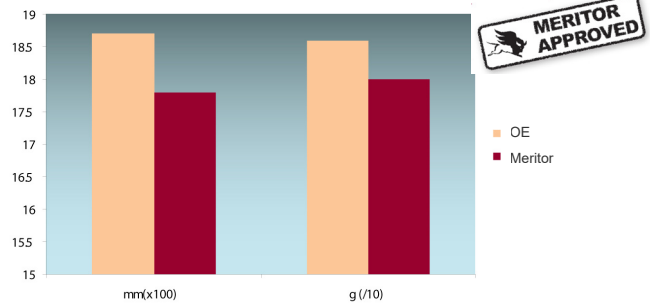

Even after being operated at over 600°C the shear strength of MDP series exceeded the industry standard

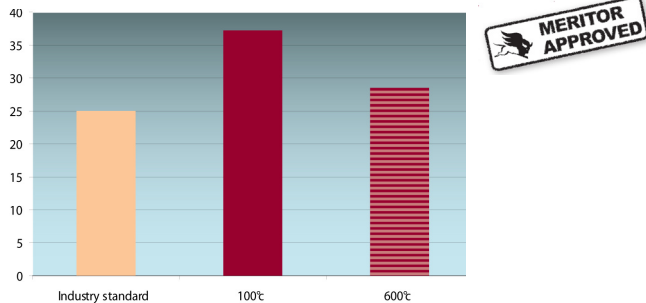

MDP series performance is equivalent to the Original Equipment Material. In fact the MDP series pads were certified against 7 different OE materials

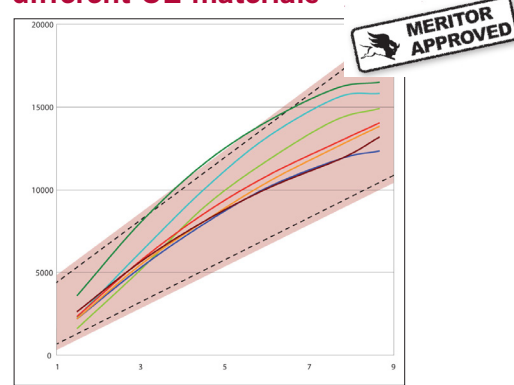

After more than 6000 brake applications at varying temperatures (up to >500°C) and varying deceleration rates and having considered every aspect of the brake pad including friction performance, pad & disc wear, friction material integrity and friction material to backplate security we finally gave the new Meritor MDP series of brake pads are seal of approval.



MAX SERIES PRODUCT INFORMATION

Meritor is the global leader in brakes for heavy duty trucks, trailers and buses. MAX pads are the newest addition to our range and represent the next step up in performance and durability from our popular MDP3000 series. Tested to far exceed ECE R90 performance requirements MAX Pads are designed specifically for those aftermarket customers who choose to run with the best.

- Outstanding friction coefficient
- Reduced rotor wear
- ECE R90 approved
- Premium braking performance



Premium: M550 Friction material – for Meritor, Knorr & Wabco brakes

Applications: High demand usage – Bus, Coach, Heavy duty truck and trailer

Back Plate: Wiremesh

- New M550 Friction material for heavy duty and bus applications.
- Excellent braking performance in high temperatures up to 500 degrees.
- More braking power.
- Consistent and reliable brake performance.
- Reduced levels of disc wear.
- Meritor Premium pads feature high quality back plate and bonding technology.
- Better pad wear performance vs other aftermarket products.
- In high stress situations Meritor Premium pad performs better than other typical aftermarket friction material.
- Lower operating costs.
- Every brake pad is hard marked “MER” Batch-code to ensure Permanent traceability.
- ECE-R90 certified.
- Complete fitting kits.

MAX SERIES FEATURES

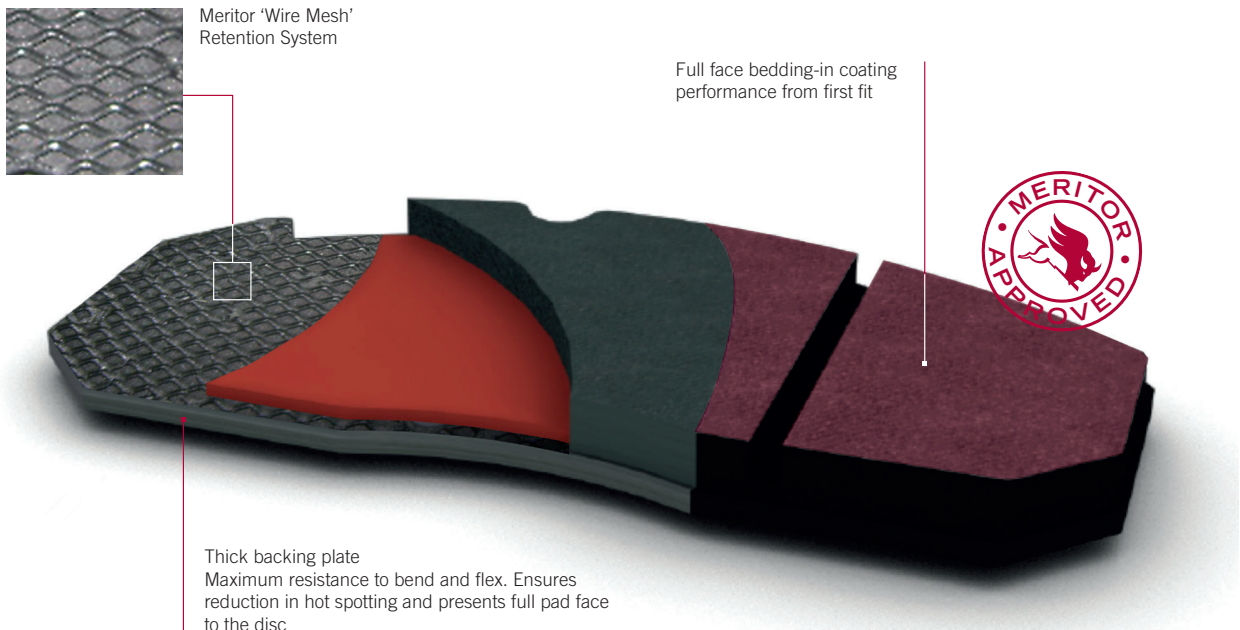

- **Torque** - Correct torque across speed, pressure & temperature.
- **Fade** - High resistance at full pressures and peak temperatures.
- **Modulation** - The strong fade resistance and reliable recovery give great confidence to the driver.
- **Recovery** - Consistent recovery levels, after any fade.
- **Material** - It's critical to ensure the material stays firmly fixed in place. Our 'Wire Mesh' retention system has the best of hot and cold shear resistance.
- **Pad Life** - A long life product with features and benefits.
- **Disc Wear** - Wear levels in line with the best of the best.
- **Disc Thermal Fatigue** - Ultimate resistance to cracking and hot-spotting of the disc.



MER 000112

Manufacturing batch / date code for traceability and Marked as MER: using the first 3 digits of MERITOR.



- Unique Premium Pads numbers: MAX + last 3 digits of WVA number "K" suffix indicates fitting kit included.
- Exclusive new Meritor 550 Friction material.
- ECE-R90 approved.

MAX SERIES TESTING

The new Meritor M550 friction material has been tested in combination of Meritor Testing and Prototype laboratory (Cameri, Italy) and an independent external certified testing laboratory, under exact Meritor quality and engineering standards.

To stop a vehicle you need to convert all of the energy of motion to heat.

- A 44 tonne truck driving at 90 km/hr. has kinetic energy of 13.75 Million Joules.
- A sports car having the same kinetic energy would be traveling at 440 km/hr.
- 13.75 Million Joules is enough energy to do this to a brake system. ▶

The new M550 friction material was tested to extremes of:

- Speed
- Temperature
- Pressure
- Deceleration

PREMIUM WEAR AND BRAKING PERFORMANCE

- Excellent braking performance in high temperatures over 500 degrees.
- More stopping and braking power.
- Reduced levels of disc wear.
- Better pad wear performance vs other aftermarket products.

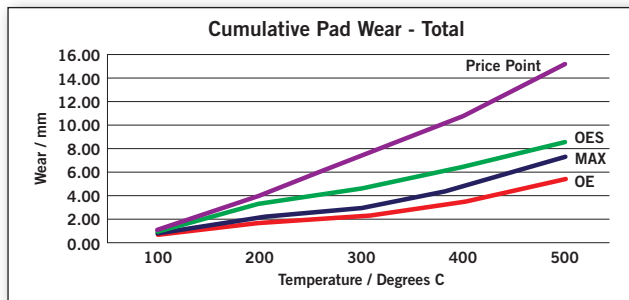

Brakes under high demand utilization reach temperatures over 500°C.

STOPPING POWER

M550 friction material has higher friction than other OE high demand friction material, giving more braking power.

Actual friction value of M550 calculates to an outstanding friction coefficient of 0.37 compared to other claimed aftermarket high performance and even OE friction materials.

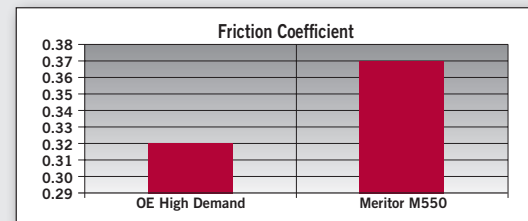

R90 PLUS TESTING

R90 PLUS Testing - Meritor MAX brake pads exceed R90 minimums

Tests for Commercial Vehicle pads are:

Hot Shear testing – This is same test as required by R90 at ambient temperature but Meritor also do it on 300°C hot pads and require the shear strength to exceed the R90 minimum of 250N/cm² of friction material (which it does).

Meritor also carry out a full range of performance testing primarily on dynamometer to review a whole range of performance characteristics across a range of pressures, speeds and temperatures that are not required by R90 testing. These tests are performed on a regular basis for production samples to ensure consistent high performance products.

Finally we carry out full scale inertia dynamometer wear testing which includes characteristic performance checks between each wear section. This testing to International standards is used to benchmark both the pad wear and rotor wear of all Meritor grades against Original Equipment (OE) and other aftermarket offers.

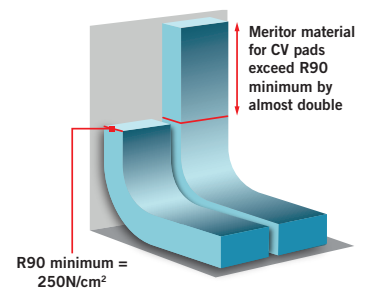





MAX SERIES RANGE



MAX PREMIUM BRAKE PADS RANGE







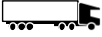

MERITOR PREMIUM PART NUMBER	MERITOR STANDARD PART NUMBER	WVA	TEXTAR	BENDIX	BRAKE SYSTEM	APPLICATION
MAX030K	MDP3030K	29030	2903009	CVP013	Meritor Elsa 1 / D3	RENAULT Magnum, Mercedes Benz 0404
MAX087K	MDP3087K	29087	2908711	CVP020	Knorr SB7 / SN7	MERCEDES Actros, DAF LF, SCANIA 4, IVECO, Mercedes Benz Bus
MAX088K	MDP3088K	29088	2928501	CVP032	Wabco Pan 17	MAN L2000, DAF LF / FA 45, IVECO Eurocargo
MAX090K	MDP3090K	29090	2909006	CVP023	Meritor D Lisa	IRISBUS / RENAULT AGORA / VOLVO B / DENNIS BUS
MAX095K	MDP3095K	29095	2932001	CVP036	Knorr SB6 / SN6	MAN 2000 series L/M, City Bus, DAF SB, Mercedes Benz 0510 Bus
MAX125K	MDP3125K	29125	2927701	CVP037	Meritor D Duco	VOLVO B / FH / FL
MAX126K	MDP3126K	29126	2931301	CVP090	Wabco Pan 19-1	DAF LF45 Series, LF55 Series, Fuwa K-Hitch, SAF SK9019W, York 2980
MAX131K	MDP3131K	29131	2913103	CVP088	Meritor Elsa 2	RENAULT Magnum E, MAN TGA Series
MAX162K	MDP3162K	29162	2933601	CVP301	Wabco Pan 22-1	SAF Axles B9, S19, S111, SKR, Z19, Z111 Series; York 2970 - 2/3, 2570, 2571, 2928 Axles
MAX165K	MDP3165K	29165	2930601	CVP092	Knorr SN / SB6	BPW SKH Axles
MAX167K	MDP3167K	29167	2930701	CVP093	Knorr SN / SB7	BPW SH Series
MAX171K	MDP3171K	29171	2930801	CVP094	Knorr SK7	BPW SH Series, Schmitz Cargobull, SAF
MAX173K	MDP3173K	29173	2917301	CVP304	Meritor ELSA 225-1	RENAULT Midlum, Volvo FL
MAX174K	MDP3174K	29174	2917401	CVP305	Meritor ELSA 225-3	RENAULT Magnum DX / VOLVO 7700, Volvo B10BLE, B12BL
MAX244K	MDP3244K	29244	2924401	CVP501	Knorr SL7	MERCEDES Actros MP4 (Rear)
MAX246K	MDP3246K	29246	2924601	CVP500	Knorr SM7	MERCEDES Actros MP4 (Front)

APPLICATION REFERENCES

 MAKE MODEL & DESCRIPTION			 ROTOR					 PAD			
			Part #	Dia	W	Ht	H	Part #	L	H	W
BPW											
Trailer Axles											
SKH Srs Axle with Disc Brakes - 19.5" Knorr Bremse Caliper	03 - on	Rear	MBR5062	377	45	160	8	MDP3095K MAX095K	211	92.5	30
SKH Srs Axle with Disc Brakes - 19.5" Knorr SB6, SN6, SB3745 Caliper	03 - on	Rear	MBR5113	377	45	165	10	MDP3095K MAX095K	211	92.5	30
ECO Plus Axles with Knorr SB6000 Caliper	98 - on	Rear	MBR5061	377	45	160	10	MDP3095K MAX095K	211	92.5	30
ECO Plus Axles with Knorr SB7000	98 - on	Rear	MBR5047	430	45	160	10	MDP3087K MAX087K	248	108	30
								MDP9001	248	108	30
ECO Plus Axles with Knorr SB7000 Caliper, 22.5" wheels without ABS		Rear	MBR5105	430	45	160	10	MDP3087K MAX087K	248	108	30
								MDP9001	248	108	30
SH Series Axles with Knorr SB4309 Caliper	03 - on							MDP3171K MAX171K	211	108	30
SH Series Axles with Knorr SB3745 Caliper, & Knorr SB7000	03 - on							MDP3165K MAX165K	211	92	30
SKH series with SB4309 Caliper	00 - on	Rear	MBR5803	430	45	159.5	10	MDP3171K MAX171K	211	108	30
TSB 4309 (BPW Caliper)			MBR5803					MDP3228K	211	115	30
DAF											
45 Series (Non LF)											
7.5 Ton	91 - 01	Front						MDP3017	191	89	23
10 Ton with Wabco Caliper	91 - 01	Front	MBR5006	312	30	137	12	MDP3017	191	89	23
CF65											
CF65 Series	01 - on	Front						MDP3835K	175	85	22
		Rear						MDP3835K	175	85	22
CF75, CF85 Series											
FA#75, FT#85 (Knorr Caliper)	98 - on	Front						MDP3087K MAX087K	248	108	30
		Rear						MDP3087K MAX087K	248	108	30
								MDP9000	248	108	30
F Series											
FA1000, FA1005	87 - on	Front						MDP3017	191	89	23
F45 Series											
FA45.150 B11/C11/C09 FA45.150-10, FA45.150 B10, FA45.160-10, FA45.160 C9/C11	91 - 00	Front						MDP3017	191	89	23
F45 Series											
Roadrunner T45	86 - on	Front						MDP3017	191	89	23
F55 Series											
FA55.150, FA55.180 B13/B15 FA55.210 B13/B15, FA55.230 B13/ B15 FAG55.210 B21	95 - 00	Front						MDP3077	205	106	27
LF45 Series											
FA45.150/170/180/220 Wabco Pan 17 Caliper	01 - 05	Front						MDP3088K MAX088K	176	86	26
FA45.XXX Wabco Pan 19.1 Caliper	06 - on	Front						MDP3126K MAX126K	211	93	30



 Indicates Meritor Original Equipment

APPLICATION REFERENCES

   MAKE MODEL & DESCRIPTION	 23	 	 ROTOR					 PAD			
			Part #	Dia	W	Ht	H	Part #	L	H	W
DAF											
LF55 Series											
FA55.170/180/220/250 FT55.180/220/250											
For Wabco Pan 19.1 Caliper	03 - on	Front						MDP3126K MAX126K	211	93	30
For Wabco Pan 19.2 Caliper	02 - 03	Rear						MDP3141	205	100	30
Please check caliper size before fitment											
For Knorr Caliper (22.5" rims)		Front						MDP3167K MAX167K	248	109.5	30
		Rear						MDP3167K MAX167K	248	109.5	30
XF95, XF105 Series											
For Knorr Caliper (22.5" rims)	98 - 10	Front						MDP3167K MAX167K	248	109.5	30
		Rear						MDP3167K MAX167K	248	109.5	30
DENNIS											
Sabre Fire Engine	95 - on	Front						MDP3090K MAX090K	249.6	114	28
Dart Series											
Dart MK1	89 - on	Front						MDP3090K MAX090K	249.6	114	28
Trident / Eagle Series											
Trident III		Front	M44D802669					MDP3087K MAX087K	248	108	30
		Rear						MDP3087K MAX087K	248	108	30
FREIGHTLINER											
Argosy / Columbia / Coronado											
For Bendix ADB225 / Knorr Bremse		Front	M44D802081	430	45	138.3	10	MDP3171K MAX171K	211	108	30
SB4309 Calipers		Rear	M44D802082	430	45	150	10	MDP3171K MAX171K	211	108	30
Bendix ESD225		Front						MDP3087K MAX087K	248	108	30
		Rear						MDP3087K MAX087K	248	108	30
FUWA / KHITCH											
Trailer Axles											
Axles fitted with Wabco Pan 19.1 Calipers, non ABS	98 - on	Rear	MBR5805	377	45	139	8	MDP3126K MAX126K	211	93	30
HENDRICKSON											
Intraax Axle											
Axles with SB7000 Knorr Bremse Calipers	80 - on							MDP3087K MAX087K	248	108	30
								MDP9000	248	108	30
Axles fitted with Conmet Alloy Hubs	00 - on	Rear	MBR5802	430	45	45	10	MDP3087K MAX087K	248	108	30
Knorr SB4309 Caliper								MDP9000	248	108	30
Axle includes high tensile bolt kit	00 - on	Rear	MBR5801	430	45	150	10	MDP3087K MAX087K	248	108	30
HIGER BUS											
Meritor Rear Axle		Rear	23123647003	430	45	150	10	MDP5990	211	108	30



 Indicates Meritor Original Equipment

APPLICATION REFERENCES

MAKE MODEL & DESCRIPTION	23	FRONT REAR	ROTOR 					PAD 			
			Part #	Dia	W	Ht	H	Part #	L	H	W
ISUZU											
GIGA series ELSA225H											
Fitted with Meritor Steer axle MFS73 * Kit with Pad Sensor	2010 -	Front Front	23123647002 23123647002	434 434	45 45	143.5 143.5	10 10	MDP5992 MDP5993			
IVECO											
Daily I											
30-8, 35-8, 35-9, 35-10	96 - on	Front Rear	MBR6009 MBR6010	290 289	22 22	110.6 84.5	6 8	MDP2018 MDP2018 MDP2003	165 165 165	66 66 66	20.3 20.3 20.3
35-12, 40-10, 45-10, 49-12	96 - on	Front	MBR6009	290	22	110.6	6	MDP2018 MDP2003	165 165	66 66	20.3 20.3
49-10	89 - on	Front Rear	MBR6009 MBR6010	290 289	22 22	110.6 84.5	6 8	MDP2018 MDP2018 MDP2003	165 165 165	66 66 66	20.3 20.3 20.3
50-12, 59-12 *MDP2003 is equipped with Sensor	92 - 99	Front Rear						MDP2022 MDP2022	175 175	69 69	20 20
Daily II											
35C11, 36C13, 35S13 Rear disc for non ABS Rear disc for ABS	05/99 - on	Front Rear Rear	MBR6005 MBR6006 MBR6007	276 276 276	22.1 16 16	72.7 66.5 66.5	5 5 5	MDP2018 MDP2003 MDP1405 MDP1405	165 165 115.8 115.8	66 66 51.3 51.3	20.3 20.3 16.8 16.8
50C11, 50C15 HPT Rear disc for non ABS Rear disc for ABS *MDP2003 is equipped with Sensor	99 - on	Front Rear Rear	MBR6005 MBR6006 MBR6007	276 276 276	22.1 16 16	72.7 66.5 66.5	5 5 5	MDP2018 MDP2003 MDP1405 MDP1405	165 165 115.8 115.8	66 66 51.3 51.3	20.3 20.3 16.8 16.8
Eurocargo											
60-12, 65-12, 79-10, 79-12, 79-13	83 - 91	Front						MDP3024	191	89	23
60 E 10, 60 E 12, 60 E 14 65 E 10, 65 E 10K, 65 E 12, 65 E 12K 65 E 14, 65 E 14K 75 E 12, 75 E 12K, 75 E 14, 75 E 14K 75 E 15, 75 E 15K	91 - 96	Front Rear						MDP2012 MDP2012	175 175	85.5 85.5	21.7 21.7
Use Fitting Kit MBA106											
60 E 10, 60 E 12, 60 E 14 65 E 10, 65 E 10K, 65 E 12, 65 E 12K 65 E 14, 65 E 14K 75 E 12, 75 E 12K, 75 E 14, 75 E 14K 75 E 15, 75 E 15K	97 - on	Front Rear						MDP3122 MDP3122	175 175	86 86	22 22
80 E 15, 80 E 18, 80 E 21, 100 100 E 15, 100 E 18, 100 E 21	91 - 96	Front Rear	MBR2649 MBR2649	322 322	30 30	134 134	8 8	MDP2004 MDP2004	175 175	78 78	22 22
Use Fitting Kit MBA107											
80 E 15K, 80 E 18K, 80 E 21K Tector	96 - on	Front Rear	MBR2649 MBR2649	322 322	30 30	134 134	8 8	MDP3122 MDP3122	175 175	86 86	22 22
110 E 15, 120 E 18, 140 E 27	91 - on	Front Rear						MDP3032K	206	107	25
120 E 24 Tector	00 - on	Front Rear						MDP3122 MDP3122	175 175	86 86	22 22
130 E 18, 130 E 24 Tector	92 - on	Front Rear	MBR5116	377	45	151	8	MDP3032K	206	107	25
150 E 15, 18, 24 Tector (Bendix Caliper)	91 - on	Front Rear	MBR5001 MBR5001	370 370	45 45	182 182	8 8	MDP3032K MDP3032K	206 206	107 107	25 25



 Indicates Meritor Original Equipment

APPLICATION REFERENCES

MAKE MODEL & DESCRIPTION	23	Front	ROTOR 					PAD 			
			Part #	Dia	W	Ht	H	Part #	L	H	W
IVECO											
Eurocargo											
150 E 18, 24, 28 Tector (Knorr Caliper)	00 - on	Front	MBR6026	375	45	151	8	MDP3095K MAX095K	211	92.5	30
		Front	MBR6029	377	45	130	14	MDP3095K MAX095K	211	92.5	30
160 E 28 Tector	00 - on	Front	MBR6029	377	45	130	14	MDP3095K MAX095K	211	92.5	30
		Rear	MBR6028	377	45	151	8	MDP3095K MAX095K	211	92.5	30
170 E 18, 23, 27	1/93 - 8/98	Front	MBR2711	430	50	102	12	MDP3011K	241	125	25
	8/98 - on	Front	MBR5063	436	45	139	12	MDP3087K MAX087K MDP9000	248	108	30
180 E 28, 225 E 28 Tector	07 - on	Front	MBR6036	432	45	138.5	12	MDP3087K MAX087K	248	108	30
		Rear	MBR6036	432	45	138.5	12	MDP3087K MAX087K MDP9000	248	108	30
230 E 28P	03 - on	Front						MDP3167K MAX167K	248	109.5	30
		Rear						MDP3167K MAX167K	248	109.5	30
Eurostar											
LD5500 (up to Ch: E30155)	01/93- 08/98	Front	MBR2711	430	50	102	12	MDP3087K MAX087K MDP9000	248	108	30
								MDP9000	248	108	30
LD5500 (from to Ch: E30155)	8/98 - on	Front	MBR5063	436	45	139	12	MDP3087K MAX087K MDP9000	248	108	30
								MDP9000	248	108	30
Eurotech											
MP4300, MP4700 MP4500 (- to Ch: E30155) MT3500 - all	up to 97	Front	MBR2711	430	50	102	12	MDP3087K MAX087K MDP9000	248	108	30
								MDP9000	248	108	30
MP4100, MP4300 MP4500 (from Ch: E30156)	98 - on	Front	MBR5063	436	45	139	12	MDP3087K MAX087K MDP9000	248	108	30
								MDP9000	248	108	30
Metrotech Bus											
Metrotech Ultra low floor bus	00 - on	Front	MBR5056	438	45	97	10	MDP3087K MAX087K MDP9000	248	108	30
								MDP9000	248	108	30
Stralis											
AD8, AD10, AD13, ADN10, ADN13 Australian built (Optional Rr disc brake)	97 - on	Front	MBR6037	432	45	154	12	MDP3087K MAX087K	248	108	30
		Rear	MBR6037	432	45	154	12	MDP3087K MAX087K	248	108	30
KASSBOHRER											
Setra											
S Series bus	77 - 89	Front Rear	MBR5110	396	48	119	10				
S Series bus	89 - on	Front Rear	MBR5003	406	48	175	10				





 Indicates Meritor Original Equipment

APPLICATION REFERENCES

MAKE MODEL & DESCRIPTION	23		ROTOR 					PAD 			
			Part #	Dia	W	Ht	H	Part #	L	H	W
KENWORTH											
K Series Trucks											
K104, K108, K200 Front with DX195 Caliper Rear with DX225 Caliper K104 Rear with EX225 Caliper	99 - 07	Front	3218N1366	378	45	156	10	MDPDX195	205	101	27
		Rear	23123615002	420	45	160	10	KIT225020	235.4	102	29
		Rear	23123642002	434	45	143	10	MDPEX225	249.9	114	30
K104, K108, K200 Front with DX195 Caliper Rear with EX225 Caliper	08 - on	Front	3218N1366	378	45	156	10	MDPDX195	205	101	27
		Rear	23123642002	434	45	143	10	MDPEX225	249.9	114	30
MFS66 Front & Rear with EX225 Caliper			23123642002	434	45	143	10	MDPEX225	249.9	114	30
T Series Trucks											
T350, T401, T604, T650, T904, T950 Front with DX195 Caliper Rear with DX225 Caliper Rear with EX225 Caliper	99 - 07	Front	3218N1366	378	45	156	10	MDPDX195	205	97	27
		Rear	23123615002	420	45	160	10	KIT225020	235.4	95	29
		Rear	23123642002	434	45	143	10	MDPEX225	249.9	99.6	29
T358, T359, T408, T409, T408SAR T409SAR, T608, T658, T659, T908, T909 Front with DX195 Caliper Rear with EX225 Caliper	08 - on	Front	3218N1366	378	45	156	10	MDPDX195	205	101	27
		Rear	23123642002	434	45	143	10	MDPEX225	249.9	114	30
MFS66 Front & Rear with EX225 Caliper			23123642002	434	45	143	10	MDPEX225	249.9	114	30
*Wear pad indicator DX195 / A2237D1330 / EX225 / MCK1358)											
KINGLONG BUS											
Meritor Rear Axle		Rear	23123647003	430	45	150	10	MDP5990	211	108	30
MACK / RENAULT											
CH & CHR Series											
Fleetliner, Valueliner, Elite, Select Metroliner Front with DX195 Caliper Rear with DX225 Caliper Rear with EX225 Caliper	97 - on	Front	3218N1366	378	45	156	10	MDPDX195	205	97	27
		Rear	23123615002	420	45	160	10	KIT225020	235.4	95	29
		Rear	23123642002	434	45	143	10	MDPEX225	249.9	99.6	29
MACK / RENAULT											
Other Australian Models											
Titan, Trident, Quantum, Superliner, Vision & Granite Front with DX195 Caliper Rear with DX225 Caliper Rear with EX225 Caliper	97 - on	Front	3218N1366	378	45	156	10	MDPDX195	205	97	27
		Rear	23123615002	420	45	160	10	KIT225020	235.4	95	29
		Rear	23123642002	434	45	143	10	MDPEX225	249.9	99.6	29
Magnum											
Magnum E Tech with D3 Caliper	02 - on	Front						MDP3131K MAX131K	249.5	118	30
		Rear	MBR5056	438	45	97	10	MDP3131K MAX131K	249.5	118	30
								MDP5073	250	118	30
Magnum DXi12, DXi13 with Meritor ELSA 225-3 Caliper	06 - on	Front						MDP3174K MAX174K	250	109	29
		Rear						MDP3174K MAX174K	250	109	29
								MDP5101	250	107	29.2
Magnum DXi12, DXi13 with Meritor ELSA 225-1 Caliper	06 - on	Front						MDP3173K MAX173K	216	99	29
		Rear						MDP3173K MAX173K	216	99	29
								MDP5102	216	97	29





 Indicates Meritor Original Equipment

APPLICATION REFERENCES

 MAKE MODEL & DESCRIPTION	 23	 	 ROTOR					 PAD			
			Part #	Dia	W	Ht	H	Part #	L	H	W
MACK / RENAULT											
Premium											
Premium incl Prime mover	96 - 02	Front	MBR5056	438	45	97	10	MDP3030K MAX030K	249.6	118.4	28.2
		Rear	MBR5056	438	45	97	10	MDP3030K MAX030K	249.6	118.4	28.2
Premium incl Prime mover	02 - on	Front	MBR5056	438	45	97	10	MDP3131K MAX131K	249.5	118	30
		Rear						MDP3131K MAX131K	249.5	118	30
								MDP5073	250	118	30
Midlum											
Midlum 150, 210, 220, 250, 270, with Wabco Pan 17 caliper 17.5" with Wabco Pan 19-2 caliper	99 - 03	Front	MBR5107	380	45	85	10	MDP3088K MAX088K	176	86	26
		Rear	MBR5112	330	34	137	6	MDP3088K MAX088K	176	86	26
		Front	MBR5107	380	45	85	10	MDP3142	205	100	30
		Rear	MBR5115	375	45	166	8	MDP3142	205	100	30
MAN											
F 90 & G90 Disc brake models											
19.502 F,FL,FS, 25.505, 26.502 DF,DFS 26.414, 26502, 27.502 DF, DFS, 32.632, 33.502, 35.343, 35.363, 35.364 48.502 VF	89 - on	Front						MDP3030K MAX030K	249.6	118.4	28.2
								MDP5038	250	118	28
F 2000 Series											
19.233 ~ 40.463 (19 t ~ 40 t)	94 - on	Front						MDP3030K MAX030K	249.6	118.4	28.2
								MDP5038	250	118	28
L 2000 Series											
6.0 ~ 10.0 Tonne 6.103 ~ 7.163, 8.103 ~ 8.224, 9.153 ~ 9.223, 10.153 ~ 10.224	93 - 96	Front									
		Rear									
6.0 ~ 10.0 Tonne 6.103 ~ 7.163, 8.103 ~ 8.224, 9.153 ~ 9.223, 10.153 ~ 10.224	96 - on	Front	MBR5013	330	34	124	12	MDP3088K MAX088K	176	86	26
		Rear						MDP3088K MAX088K	176	86	26
M 2000 Series											
12.163 ~ 12.224 - 12 Tonnes	96 - on	Front	MBR5013	330	34	124	12	MDP3088K MAX088K	176	86	26
		Rear						MDP3088K MAX088K	176	86	26
14.163 ~ 14.264 - 14 Tonnes	96 - on	Front	MBR5014	377	45	128	10	MDP3095K MAX095K	211	92.5	30
		Rear	MBR5014	377	45	128	10	MDP3095K MAX095K	211	92.5	30
								MDP9002	210	90	30
25.224 ~ 25.264 - 25 Tonnes	96 - on	Front						MDP3030K MAX030K	249.6	118.4	28.2
								MDP5038	250	118	28
TGA Series											
18.360, 26.410, 26.480, 32, 480, 33.410 41.480	04 - on	Front	MBR5057	432	45	130	12	MDP3131K MAX131K	249.5	118	30
		Rear	MBR5068	432	45	135	10	MDP3131K MAX131K	249.5	118	30
								MDP5073	250	118	30



 Indicates Meritor Original Equipment

APPLICATION REFERENCES

MAKE MODEL & DESCRIPTION			ROTOR 					PAD 			
			Part #	Dia	W	Ht	H	Part #	L	H	W
MAN											
TGL Series											
8 - 12 ton	05 - on	Front						MDP3148K	173.6	84	27
		Rear						MDP3148K	173.6	84	27
TGM Series											
12.240 ~ 30.340	07 - on	Front						MDP3095K MAX095K	211	92.5	30
		Rear						MDP3095K MAX095K	211	92.5	30
								MDP9002	210	90	30
TGX Series											
18.360, 18.400, 18.440, 18.480, 18.500	07 - on	Front						MDP3087K MAX087K	248	108	30
All with Knorr SB7000 Caliper		Rear						MDP3087K MAX087K	248	108	30
								MDP9000	248	108	30
MERCEDES BENZ											
Actros											
All Disc brake models - 1840, 1841	96 - 03	Front	MBR5016HD	430	45	132	10	MDP3087K MAX087K	248	108	30
2640, 2641, 2643, 2644, 2648, 2650		Rear	MBR5016HD	430	45	132	10	MDP3087K MAX087K	248	108	30
2653, 2654, 3236, 3240, 3241, 3243, 3244, 3254								MDP9000	248	108	30
All Disc brake models - 1840, 1841	04 - 13	Front	MBR5128	430	45	143	10	MDP3087K MAX087K	248	108	30
2640, 2641, 2643, 2644, 2648, 2650		Rear	MBR5128	430	45	143	10	MDP3087K MAX087K	248	108	30
2653, 2654, 3236, 3240, 3241, 3243, 3244, 3254								MDP9000	248	108	30
A006 4201420 (KNORR SM7)		Front						MDP3246K MAX246K	248	108	30
A006 4201520 (KNORR SL7)		Rear						MDP3244K MAX244K	248	108	30
Axor											
1831 ~ 3557		Front	MBR5016HD	430	45	132	10	MDP3087K MAX087K	248	108	30
		Rear	MBR5016HD	430	45	132	10	MDP3087K MAX087K	248	108	30
								MDP9000	248	108	30
Bus & Coach											
Bus O 404	91 - on	Front						MDP3030K MAX030K	249.6	118.4	28.2
		Rear						MDP3030K MAX030K	249.6	118.4	28.2
								MDP5038	250	118	28
Sprinter											
All Van & Bus	00 - on	Front	MBR6011	275.7	22	77	5	MDP1038	156.5	64.8	20
Rear ATE Brakes (Pls check rotor diam.)		Rear	MBR6012	272	15.9	97	5	MDP1039	141.4	50.1	17.3
Rear ATE Brakes	Early	Rear	MBR6014	258	12	96.7		MDP1045	156	54.3	18.8
Rear Bosch Brakes		Rear	MBR6012	272	15.9	97	5	MDP1306	125.8	61.5	18.9
Rear Bosch Brakes		Late	Rear	MBR6013	284.8	22	92.9	6	MDP1306	125.8	61.5
Vario Truck & Bus											
Vario 0811D, 0814D	87 - 95	Front						MDP3835K	175	85	22
								MDP5109	175	84	22
609D, 709D, 711D	87 - 95	Front						MDP3835K	175	85	22





 Indicates Meritor Original Equipment

APPLICATION REFERENCES

MAKE MODEL & DESCRIPTION	23		ROTOR 					PAD 			
			Part #	Dia	W	Ht	H	Part #	L	H	W
MERCEDES BENZ											
Vario Truck & Bus											
612D, 614D, 812D with 16" wheels								MDP3835K	175	85	22
Disc for Brembo rear brake	96 - on	Front						MDP3835K	175	85	22
Disc for Meritor rear brake		Rear									
Vario 812 TD								MDP3835K	175	85	22
with 17.5" wheels	96 - on	Front						MDP3835K	175	85	22
		Rear						MDP5109	175	84	22
Vario 819, 814 TD								MDP3835K	175	85	22
with 17.5" wheels	96 - on	Front	MBR5075	324	30	121	6	MDP3835K	175	85	22
		Rear						MDP5109	175	84	22
MERITOR AXLES											
Trailer Axles											
DX195 LM Axles	99 - 05	Rear	MBR5073	378	45	150	10	MDP3124K	205.4	102	27
			MBR9018	377	45	150	10	MDP5076	205	100	27
DX195 LM Axles	05 - on	Rear	MBR5079	378	45	150	8	MDP3124K	205.4	102	27
			MBR9014	377	45	150	8	MDP5076	205	100	27
DX195 LM Axles with ABS	05 - on	Rear	MBR5808	378	45	150	8	MDP3124K	205	102	27
Rotor with built in ABS pole ring - 90 teeth (NZD APPLICATION ONLY)											
DX195 LM Axles fitted with American wheels	04 - on	Rear	MBR9015	377	45	150	10	MDP3124K	205.4	102	27
								MDP5076	205	100	27
DX195 TM Axles	99 - 05	Rear	MBR5079	378	45	150	8	MDP3124K	205.4	102	27
			MBR9014	377	45	150	8	MDP5076	205	100	27
DX195 TM Axles with ABS	05 - on	Rear	MBR5808	378	45	150	8	MDP3124K	205	102	27
Rotor with built in ABS pole ring - 90 teeth (NZD APPLICATION ONLY)											
ELSA 195 TM/LM/LC axles	03 - on	Rear	MBR5079	378	45	150	8	MDP3169K	210.5	99.75	30
			MBR9014	377	45	150	8	MDP5093	210	104	30
								MDP5103	210	99	29
EX225								KIT2252L2CD			
TM ELSA 195	05 - on	Rear	MBR5808	378	45	150	8	MDP3169K	211	99.8	30
HMX axle code DX195								MDP5103	210	99	29
KMX axle code ELSA195											
Rotor with built in ABS pole ring - 90 teeth (NZD APPLICATION ONLY)											
TA & TC											
Duco and Elsa2			MBR9004	434	45	150	10	MDP5057	250	110	30
								MDP3171K	211	108	30
								MAX171K			
Truck Axles											
DX 195 Steer Axle		Front	3218N1366	378	45	156	10	MDPDX195	205	97	27
DX 225 Drive Axle		Rear	23123615002	420	45	160	10	KIT225020	235.4	95	29
EX 225 Drive Axle		Rear	23123642002	434	45	143	10	MDPEX225	249.9	99.6	29
SAF											
Trailer Axles											
SAF/Sauer B. discs 19.5" wheels with	98 - on	Rear	MBR5059	375	45	139.5	12	MDP3126K	211	93	30
Wabco Pan 19-1 Caliper								MAX126K			
								12999737VT	211	93	30
SAF/Sauer B. discs 19.5" wheels with	98 - on	Rear	MBR5072	377	45	157	8	MDP3126K	211	93	30
Wabco Pan 19-1 Caliper								MAX126K			
								12999737VT	211	93	30

 Indicates Meritor Original Equipment

APPLICATION REFERENCES

 MAKE MODEL & DESCRIPTION	 23	 	 ROTOR					 PAD			
			Part #	Dia	W	Ht	H	Part #	L	H	W
SAF											
Trailer Axles											
SAF/Sauer B. discs 22.5" wheels with Knorr SB7000 Caliper	98 - on	Rear	MBR5074	430	45	160	10	MDP3087K MAX087K	248	108	30
SAF Pan 19.1, built in ABS ring 80 teeth	00 - on	Rear	MBR5804	377	45	158	10	MDP3126K MAX126K	211	93	30
SAF Intradisc 19.5" wheels on Wabco Pan 19-1 Caliper	04 - on	Rear						MDP3126K MAX126K	211	93	30
								12999737VT	211	93	30
SAF Axles with Knorr SB6000 Caliper		Rear						MDP3095K MAX095K	211	92.5	30
								MDP9003	211	92.5	30
SAF/Sauer B. Disc 19.5" wheels on Wabco Pan 19-1 Caliper	04 - on	Rear						MDP3126K MAX126K	211	93	30
SAF Intradisc 22.5" wheels on Wabco Pan 22-1 Caliper	04 - on	Rear	MBR5125	430	45	48	10	MDP3162K MAX162K	210	110	31
								12999796	210	110	30
SAF/Sauer Brake Discs - Australian Axle 377 x 45 Knorr SB6000 Caliper Wabco Pan 19-1 Caliper (NZD APPLICATION ONLY)	05 - on	Rear	MBR5807		45	158	10				
SAF/Sauer Brake Discs - SK RS9019 19.5" Wheels - Knorr SB6000 Caliper (NZD APPLICATION ONLY)	98 - on	Rear	MBR5807		45	158	10				
SCANIA											
4 Series											
94, 124, 144 series Trucks	95 - on	Front	MBR5025	430	45	131	10	MDP3087K MAX087K	248	108	30
		Rear	MBR5025	430	45	131	10	MDP3087K MAX087K	248	108	30
									MDP9000	248	108
CN 94 Omnacity bus	96 - on	Rear	MBR5025	430	45	131	10	MDP3087K MAX087K	248	108	30
								MDP9000	248	108	30
STERLING											
AT & LT Series Trucks											
All trucks fitted with Bendix ADB225X Calipers front & rear		Front	M44D802081					MDP3171K MAX171K	211	108	30
		Rear	M44D802082					MDP3171K MAX171K	211	108	30
TMC											
Trailer Axles											
Axles fitted with Wabco 19.1 Calipers non ABS	98 - on	Rear	MBR5805	377	45	139	8 x M14	MDP3126K MAX126K	176	89	29
VOLVO											
Bus											
B7 Series Bus		Front Rear	MBR5108	438	45	127	10	MDP3090K MAX090K	249.6	114	28
B12 Bus	95 - 05	Front Rear	MBR5108	438	45	127	10	MDP3090K MAX090K	249.6	114	28
B10BLE, B12BL, B7R * Requires Installation KIT5806	00 - on	Front	MBR5806*	434	45	232	24	MDP3174K MAX174K	250	109	29
		Rear	MBR5806*	434	45	232	24	MDP3174K MAX174K	250	109	29





 Indicates Meritor Original Equipment

APPLICATION REFERENCES

MAKE MODEL & DESCRIPTION	23	FRONT REAR	ROTOR					PAD			
			Part #	Dia	W	Ht	H	Part #	L	H	W
VOLVO											
FE Series											
FE Series with Meritor ELSA 225-3 Caliper	05 - on	Front						MDP3174K MAX174K	250	109	29
		Rear						MDP3174K MAX174K	250	109	29
								MDP5104	250	107	29
FH Series											
FH12 380, 420, 460	00 - on	Front						MDP3125K MAX125K	249.5	111	29
		Rear						MDP3125K MAX125K	249.5	111	29
FH16 550	00 - on	Front						MDP3125K MAX125K	249.5	111	29
		Rear						MDP3125K MAX125K	249.5	111	29
FH12, FH16	05 - on	Front						MDP3174K MAX174K	250	109	29
		Rear						MDP3174K MAX174K	250	109	29
								MDP5104	250	107	29
FL Series											
FL Srs Trucks with Meritor B Duco Caliper - 17.5" wheels	00 - on	Front	MBR9002	336.8	30	100.5	10	MDP3136K	175.5	89	29
		Rear	MBR9003	336	30	139	8	MDP3136K	175.5	89	29
								MDP5052	176	89	29
FL Srs Trucks with Meritor C Duco Caliper - 19.5" wheels	00 - on	Front	MBR9000					MDP3137K	210	102	29
		Rear		375	45	116	14	MDP3137K	210	102	29
								MDP5053	210	102	30
FL II 240, 260, 280 with Meritor ELSA 225-1 Caliper	06 - on	Front						MDP3173K MAX173K	216	99	29
		Rear						MDP3173K MAX173K	216	99	29
								MDP5106	216	99.5	29
FL Series											
FL II 290 with Meritor ELSA 225-1 Caliper	06 - on	Front						MDP3173K MAX173K	216	99	29
		Rear						MDP3173K MAX173K	216	99	29
								MDP5106	216	99.5	29
FL II 290 with Meritor ELSA 225-3 Caliper	06 - on	Front						MDP3174K MAX174K	250	109	29
		Rear						MDP3174K MAX174K	250	109	29
								MDP5104	250	107	29
FM Series											
FM 7	99 - on	Front						MDP3125K MAX125K	249.5	111	29
		Rear						MDP3125K MAX125K	249.5	111	29
FM 9 340 with Meritor D Duco Caliper FM12 340, 380, 420 - D Duco Caliper	01 - 05	Front	MBR5124	434	45	150	10	MDP3125K MAX125K	249.5	111	29
		Rear	MBR5124	434	45	150	10	MDP3125K MAX125K	249.5	111	29
			MBR9004	434	45	150	10	MDP5057	250	110	30
FM/FH 22.5" Wheels *Requires Installation KIT5806	00 - on	Front	MBR5806*	434	45	232	24	MDP3174K MAX174K	250	109	29
		Rear	MBR5806*	434	45	232	24	MDP3174K MAX174K	250	109	29
FM Series with Meritor ELSA 225-3 Caliper	05 - on	Front						MDP5104	250	107	29
		Rear						MDP5104	250	107	29

Indicates Meritor Original Equipment

APPLICATION REFERENCES





 MAKE MODEL & DESCRIPTION			ROTOR 					PAD 			
			Part #	Dia	W	Ht	H	Part #	L	H	W
YORK											
Trailer Axles											
Axles with Wabco Pan 19-1, 19.5" wheels	98 - on	Rear	MBR5805	377	45	139	8	MDP3126K MAX126K	211	93	30
Axles with Wabco Pan 19-1, 19.5" wheels	00 - on	Rear						MDP3126K MAX126K	211	93	30
WESTERN STAR											
Constellation & Heritage Class Trucks											
All trucks fitted with Bendix ADB225X Calipers front & rear		Front Rear	M44D802081 M44D802082	430 430	45 45	138.30 150	10 10	MDP3171K MAX171K	211 211	108 108	30 30
YUTONG BUS											
Meritor Rear Axle		Rear	23123647003	430	45	150	10	MDP5990	211	108	30

 Indicates Meritor Original Equipment

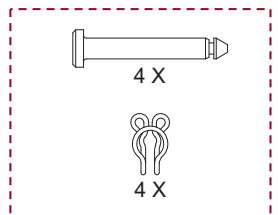
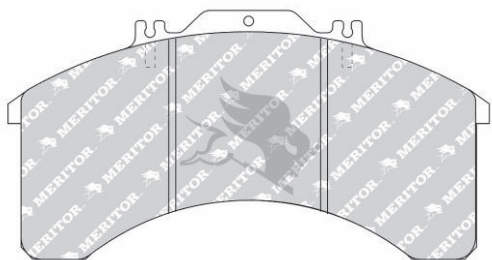
MDP3000 RANGE



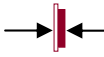

MDP3011K = 4 x

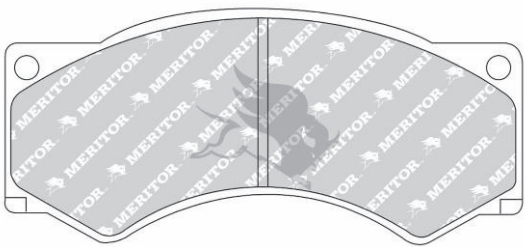

WVA				
29 011	241.0	125.0	25.0	KNORR



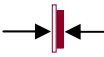

MDP3017 = 4 x

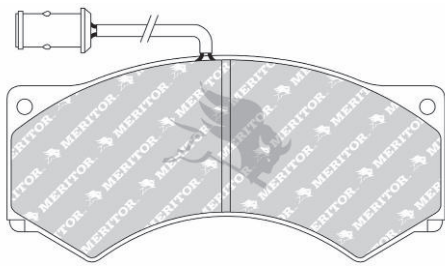

WVA				
29 017	191.0	89.0	23.0	WABCO 456 F-Ö

MDP3024 = 2 x + 2 x



WVA				
29 024	191.0	89.0	23.0	WABCO 456 F- Ö

MDP3000 RANGE

MDP3030K

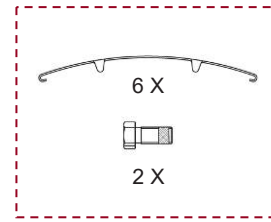
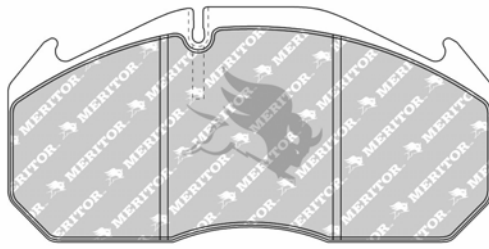

WVA
29 030



249.6



118.4

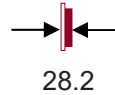

28.2

 **MERITOR ELSA 1/D3**

MDP3032K

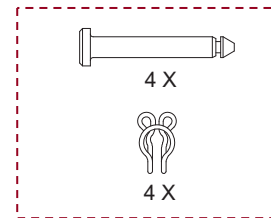
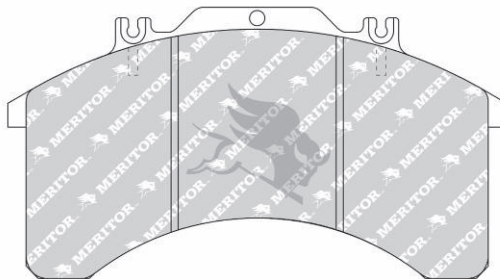

WVA
29 032



206.0



107.0

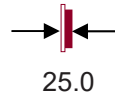

25.0

 **KNORR**

MDP3077

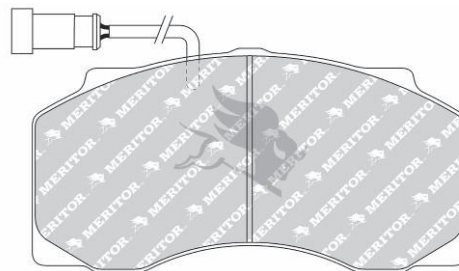

WVA
29 077



205.0



106.0



27.0

 **WABCO 1600 V-G**

MDP3000 RANGE

MDP3087K

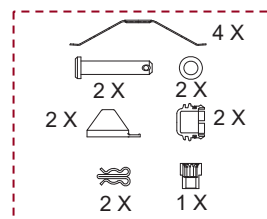
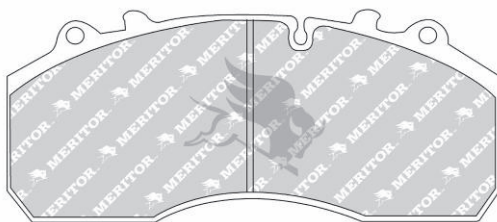

WVA
29 087

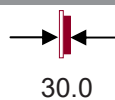
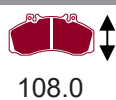
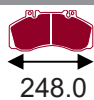

MDP3088K

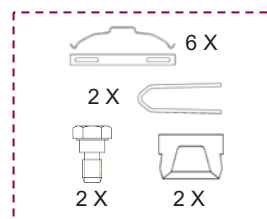
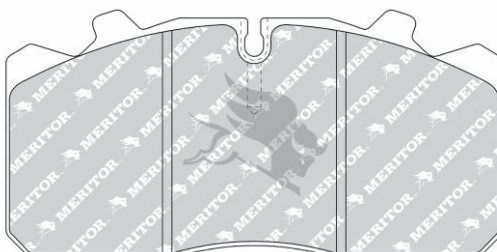

WVA
29 088

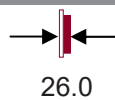
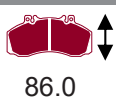
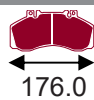

MDP3090K

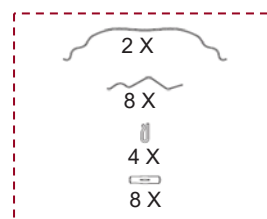
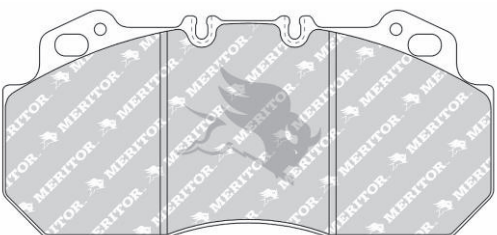

WVA
29 090

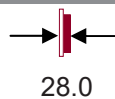

MDP3000 RANGE

MDP3095K

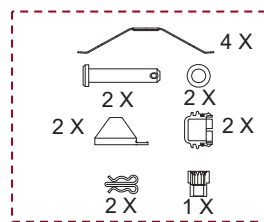
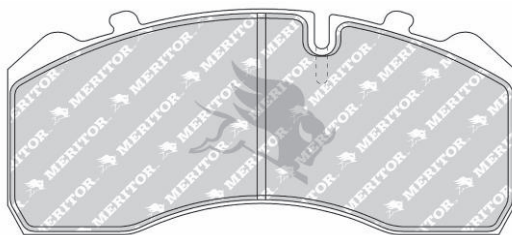

WVA
29 095

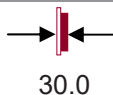

MDP3122

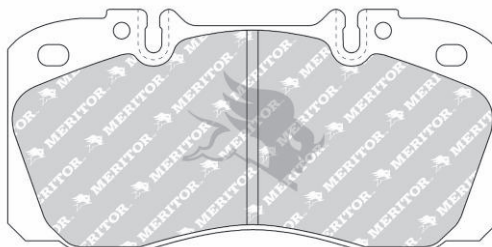

WVA
29 122

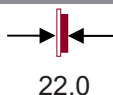
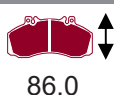

MDP3124K

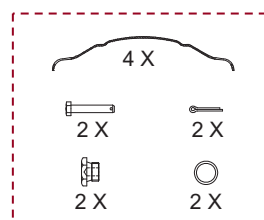
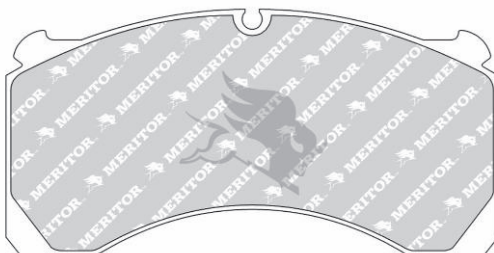

WVA
29 124

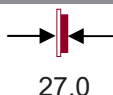

MDP3000 RANGE

MDP3125K

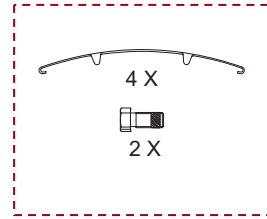
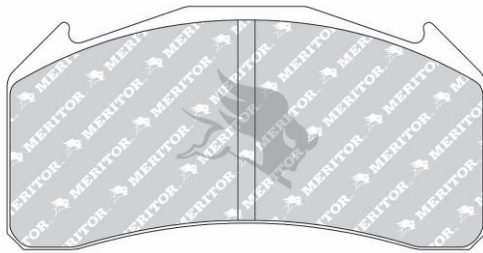

WVA
29 136

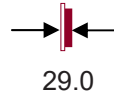

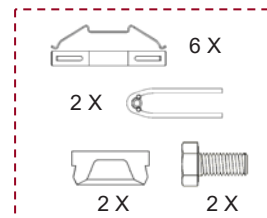
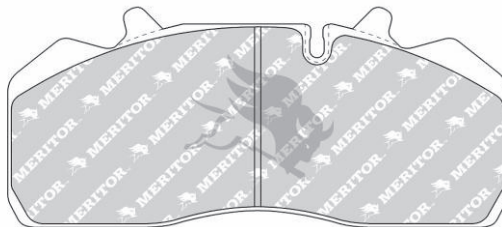

MERITOR B DUCO

MDP3126K

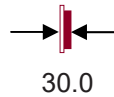
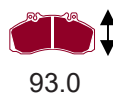

WVA
29 126



WABCO PAN 19-1

MDP3131K

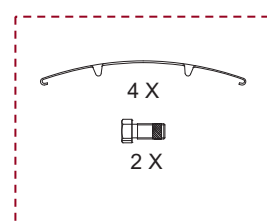
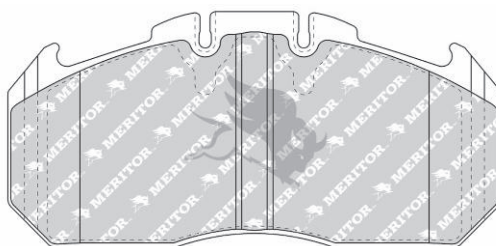

WVA
29 131



MERITOR ELSA 2

MDP3000 RANGE

MDP3136K

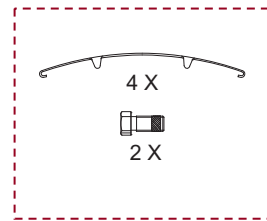
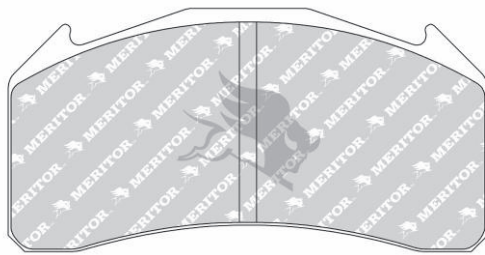

WVA	175.5	89.0	29.0	MERITOR B DUCO
29 136				

MDP3137K

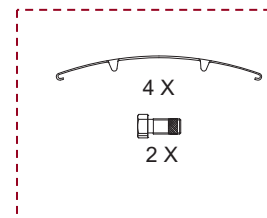
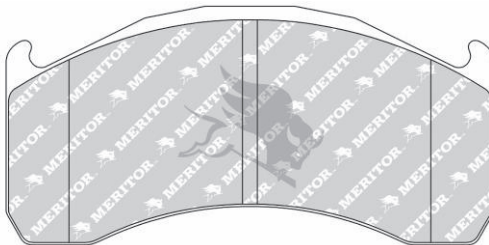

WVA	210.0	102.0	29.0	MERITOR C DUCO
29 137				

MDP3141

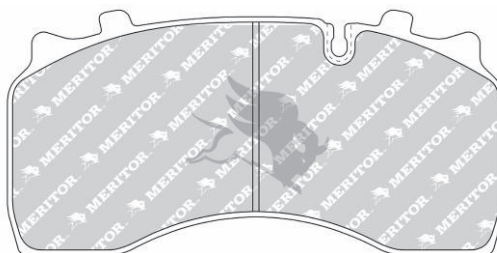

WVA	205.0	100.0	30.0	WABCO PAN 19-2
29 141				

MDP3000 RANGE

MDP3142 = 4 x

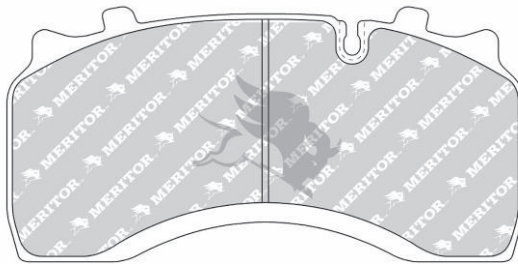

WVA				
29 142	205.0	100.0	30.0	WABCO PAN 19-2

MDP3148K = 2 x + 2 x

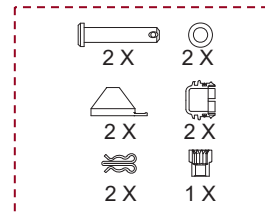
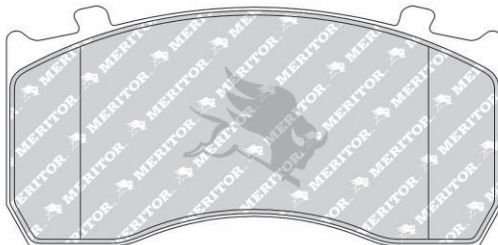

WVA				
29 148	173.6	84.0	27.0	KNORR SB5000

MDP3162K = 4 x

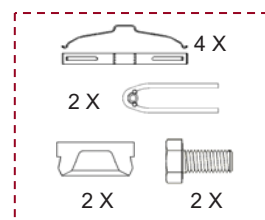
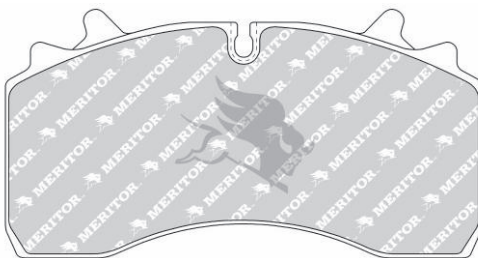

WVA				
29 162	210.00	110.0	31.0	WABCO PAN 22-1

MDP3000 RANGE

MDP3165K

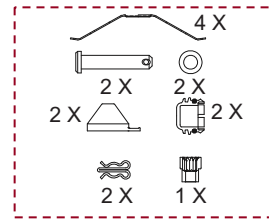
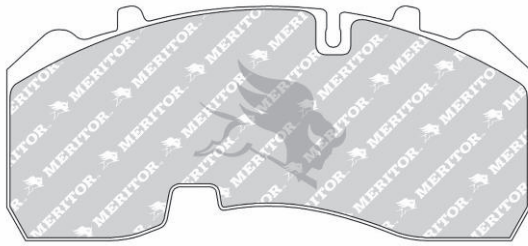

WVA				
29 165	211.0	92.0	30.0	KNORR SB6000

MDP3167K

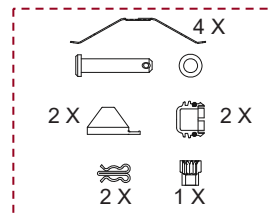
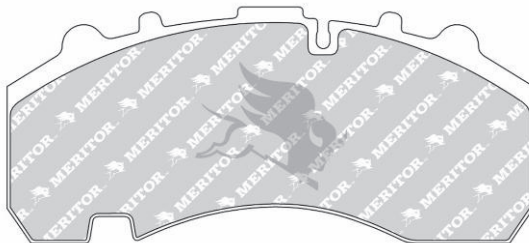

WVA				
29 167	248.0	109.5	30.0	KNORR SB7000

MDP3169K

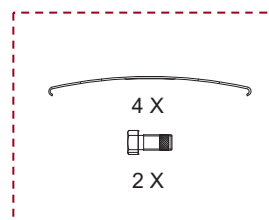
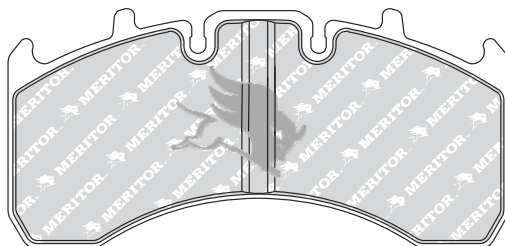

WVA				
29 169	210.5	99.75	30.0	MERITOR ELSA 195

MDP3000 RANGE

MDP3171K

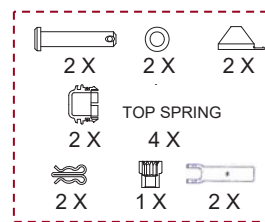
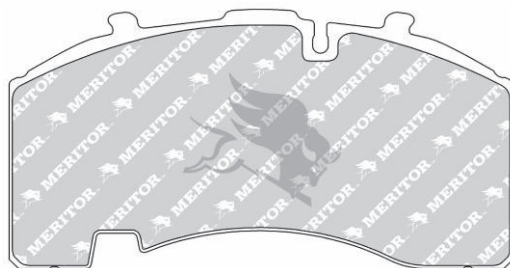

WVA
29 171

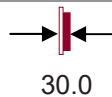

MDP3173K

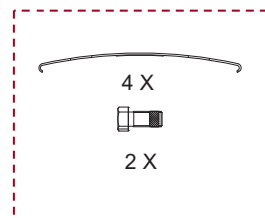
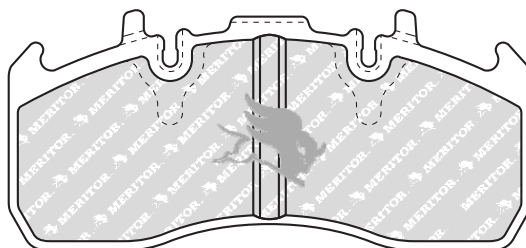

WVA
29 173

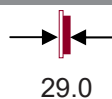
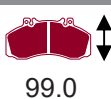

MDP3174K

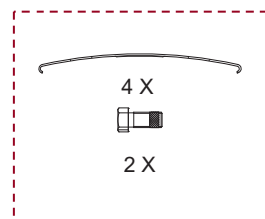
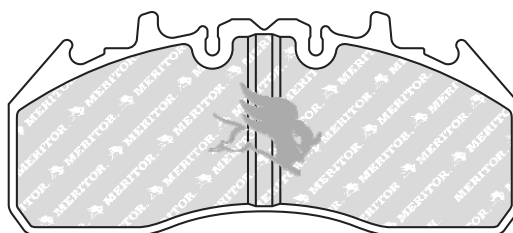

WVA
29 174

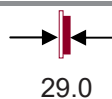
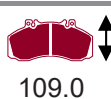

MDP3000 RANGE

MDP3228K

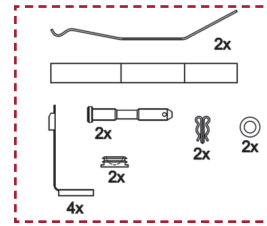
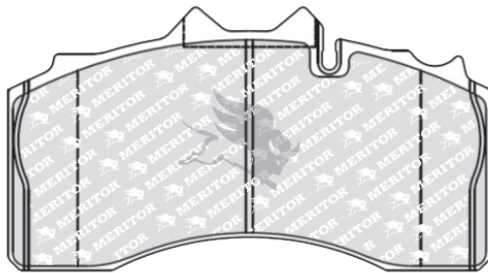
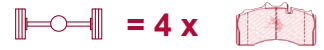

WVA
29228



211.0



114.0

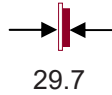

29.7



BPW TSB4309

MDP3835K

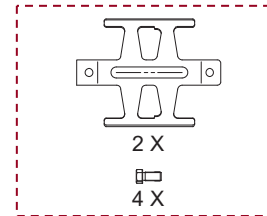
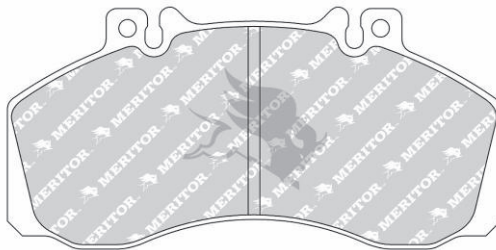

WVA
29 835



175.0

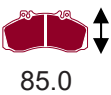

85.0

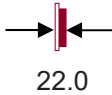

22.0



MERITOR 'B' FRAME

MDP3143K

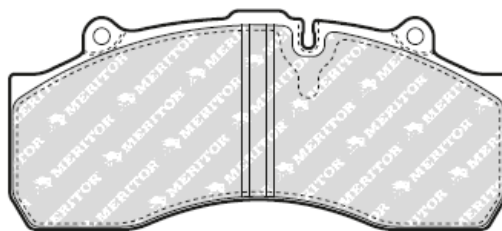

WVA

29120 29143 29185



248



30



HALDEX 3DB22

MDP3000 RANGE

MDP3244K

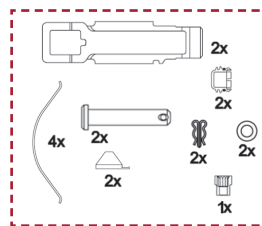

WVA
29244

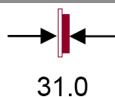

MDP3246K

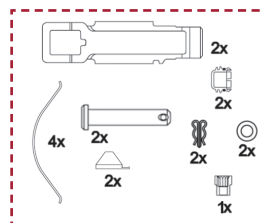

WVA
29246

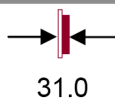

MERITOR CALIPERS

MDPDX195

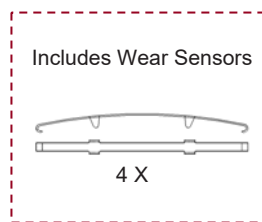
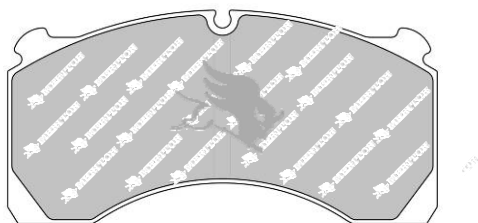

WVA

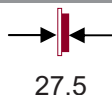

MERITOR DX195

KIT225020

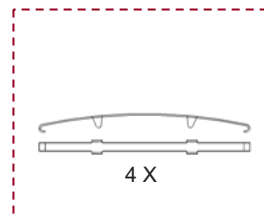
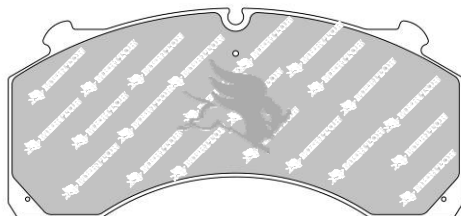

WVA

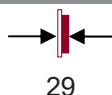

MERITOR DX225

MDPEX225

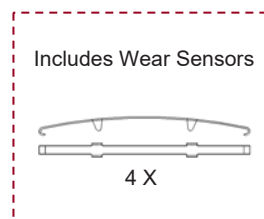
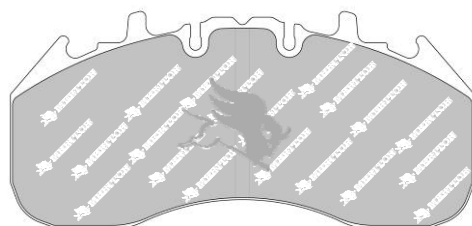

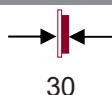

WVA



MERITOR EX225

MAX RANGE

MAX030K  = 4 x 

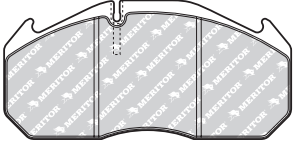

Renault



WVA
29030
29083
29113

249.6mm
118.4mm
28.2mm

 Meritor
Elsa 1/D3

MAX087K  = 4 x 

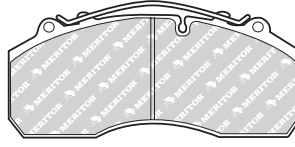

DAF
Iveco
Mercedes
Scania



WVA
29059 29042
29106 29087
29109 29108
29179 29163
29253 29202

248.0mm
108.0mm
30.0mm

 Knorr
SB7/SN7

MAX088K  = 4 x 

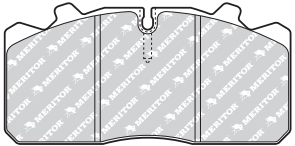

DAF
Iveco
MAN



WVA
29088

176.0mm
86.0mm
26.0mm

 Wabco
Pan 17

MAX090K  = 4 x 

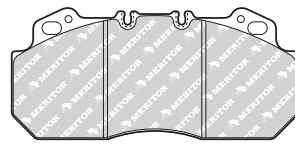

Dennis
Irisbus
Renault
Volvo



WVA
29090

249.6mm
114.0mm
28.0mm

 Meritor
D LISA

MAX095K  = 4 x 

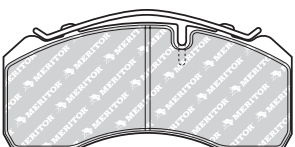

DAF
MAN



WVA
29095
29197

211.0mm
92.5mm
30.0mm

 Knorr
SB6/SN6

MAX125K  = 4 x 

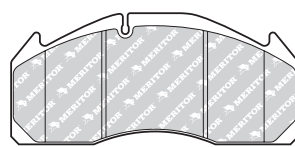

Volvo



WVA
29125
29277

249.5mm
111.0mm
29.0mm

 Meritor
D DUCCO

MAX126K  = 4 x 

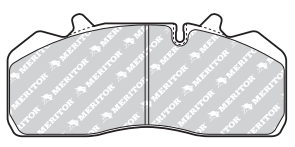

SAF



WVA
29126
29159

211.0mm
93.0mm
30.0mm

 Wabco
Pan 19-1

MAX131K  = 4 x 

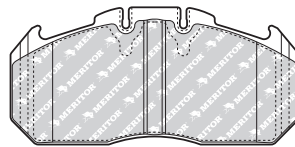

MAN
Renault



WVA
29131

249.5mm
118.0mm
30.0mm

 Meritor
ELSA 2

MAX165K  = 4 x 

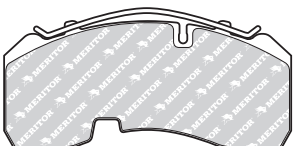

BPW



WVA
29165
29306

211.0mm
92.0mm
30.0mm

 Knorr
SB6/SN6

MAX162K  = 4 x 

SAF
SMB

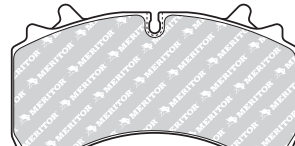



WVA
29162

210.0mm
110.0mm
31.0mm

 Wabco
Pan 22-1

MAX RANGE

MAX171K  = 4 x 

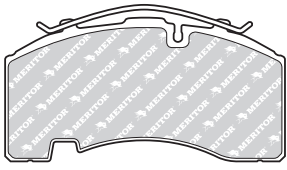

BPW
SAF
Schmitz



WVA
29158
29171
29308

211.0mm
108.0mm
30.0mm

 Knorr
SK7

MAX167K  = 4 x 

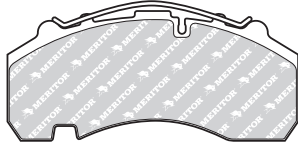

BPW



WVA
29167
29307

248.0mm
109.5mm
30.0mm

 Knorr
SB7/SN7

MAX174K  = 4 x 

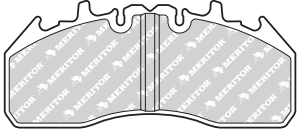

Renault
Volvo



WVA
29174
29218
29273

250.0mm
107.0mm
29.0mm

 Meritor
ELSA 225-3

MAX173K  = 4 x 

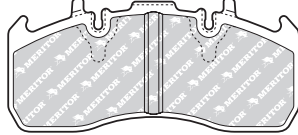

Renault



WVA
29173
29203

210.0mm
102.0mm
29.0mm

 Meritor
ELSA 225-1

MAX246K  = 4 x 

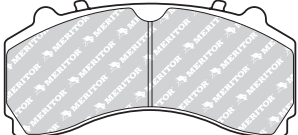

Mercedes



WVA
29246

244.5mm
113.9mm
31.0mm

 Knorr
SM7

MAX244K  = 4 x 

Mercedes

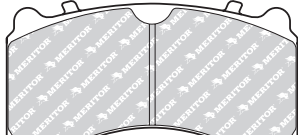

WVA
29244

207.0mm
113.9mm
31.0mm

 Knorr
SL7

CROSS REFERENCE TO MERITOR BRAKE PADS

ATAP	MERITOR
CDP1000	MDP3011K
CDP1001	MDP3095K
CDP1001	MAX095K
CDP1001	MDP9002
CDP1002	MDP3124K
CDP1002	MDP5076
CDP1003	MDP2023
CDP1003	MDP3087K
CDP1003	MDP9000
CDP1005	MDP3835K
CDP1005	MDP5109
CDP1006	MDP3030K
CDP1006	MAX030K
CDP1007	MDP3122
CDP1008	MDP2003
CDP1008	MDP2018
CDP1014	MDP3017
CDP1015	MDP3126
CDP1016	MDP5453
CDP1019	MDP3090K
CDP1019	MAX090K
CDP1020	MDP3088
CDP1022	MDP3032K
CDP1023	MDP2012
CDP1024	MDP2022
CDP1025	MDP3024
CDP1026	MDP3125K
CDP1026	MAX125K
CDP1027	MDP3077
CDP1030	MDP3137K
CDP1031	MDP3131K
CDP1031	MAX131K
CDP1031	MDP5073
CDP1032	KIT225020
CDP1034	MDP3169K
CDP1034	MDP5093
CDP1035	MDP2004
CDP1037	MDP3171K
CDP1037	MAX171K
CDP1038	MDP3165K
CDP1038	MAX165K
CDP1039	MDP3142
CDP1040	MDP5101
CDP1040	MDP5104
CDP1041	MDP3167K
CDP1041	MAX167K
CDP1042	12999796
CDP1042	MDP3162
CDP1043	MDP3136K
CDP1046	MDP3165K
CDP1047	MDP3171K

ATAP	MERITOR
CDP1050	MDP5102
CDP1050	MDP5106
CDP1050	MDP3173K
CDP1054	MDP3143K

BENDIX	MERITOR
802078	MDP3171K
802078	MAX171K
CVP013	MAX030K
CVP016	MDP2012
CVP017	MDP2022
CVP019	MDP2004
CVP020	MAX087K
CVP020K	MDP2023
CVP020K	MDP3087K
CVP020K	MAX087K
CVP020K	MDP9000
CVP022	MDP3077
CVP023	MAX090K
CVP023K	MDP3090K
CVP023K	MAX090K
CVP024	MDP3124K
CVP024	MDP5076
CVP025	MDP3122
CVP026	MDP2003
CVP026	MDP2018
CVP027	MDP3024
CVP032	MDP3088K
CVP032	MAX088K
CVP032	MAX088K
CVP035	MDP3148K
CVP036	MAX095K
CVP036K	MDP3095K
CVP036K	MAX095K
CVP036K	MDP9002
CVP037	MDP3125K
CVP037	MAX125K
CVP038K	MDP3136K
CVP039	MDP3137K
CVP086	MDP3141
CVP088	MDP3131K
CVP088	MAX131K
CVP088	MDP5073
CVP088	MAX131K
CVP089K	MDP3143K
CVP090	MAX126K
CVP090K	MDP3126
CVP092	MDP3165K
CVP092	MAX165K
CVP093	MDP3167K
CVP093	MAX167K

CROSS REFERENCE TO MERITOR BRAKE PADS

BENDIX	MERITOR
CVP094	MDP3171K
CVP094	MAX171K
CVP096K	MDP3162
CVP100	MDP5106
CVP1006	KIT225020
CVP101	MDP5104
CVP159	MDP5083
CVP301	MAX162K
CVP303	MDP3169K
CVP304	MAX173K
CVP305	MAX174K
CVP500	MAX246K
CVP501	MAX244K
CVP503	MDP3228K

BOVA	MERITOR
204552	MDP3087K
204552	MAX087K

BPW	MERITOR
0203121400	MDP9001
0203121500	MDP9003
0203121600	MDP9003
0203121700	MDP9001
0509290040	MDP3165K
0509290040	MAX165K
0509290050	MDP3165K
0509290050	MAX165K
0509290060	MDP3171K
0509290060	MAX171K
0509290070	MDP3167K
0509290070	MAX167K
0509290080	MDP3171K
0509290080	MAX171K
0509290090	MDP3167K
0509290090	MAX167K
0509290100	MDP3165K
0509290100	MAX165K
0509290130	MDP3228K
0536270010	MDP9001
0536270020	MDP3087K
0536270020	MAX087K
0536270020	MDP9001
0980102200	MDP9001
0980102450	MDP3167K
0980102450	MAX167K
0980102570	MDP3087K
0980102570	MAX087K
0980102570	MDP9001
0980102750	MDP3165K
0980102750	MAX165K
0980102750	MDP9003

BPW	MERITOR
0980102920	MDP3087K
0980102920	MAX087K
0980102920	MDP9001
0980102930	MDP3165K
0980102930	MAX165K
0980102930	MDP9003
0980106200	MDP3087K
0980106200	MAX087K
0980106200	MDP9001
0980106210	MDP9003
0980106210	MDP3165K
0980106210	MAX165K
0980106360	MDP9001
0980106430	MDP3165K
0980106430	MAX165K
0980106440	MDP3171K
0980106440	MAX171K
0980106950	MDP3171K
0980106950	MAX171K
0980106960	MDP3167K
0980106960	MAX167K
0980107090	MDP3165K
0980107090	MAX165K
0980107240	MDP3165K
0980107260	MDP3171K
0980107260	MAX171K
0980107570	MDP3228K
0980107940	MDP3228K
0980107960	MDP3228K
0980107971	MDP3228K
0980108150	MDP3165K
0980108160	MDP3171K

DAF	MERITOR
1436901	MDP3088K
1436901	MAX088K
1439324	MDP3087K
1439324	MAX087K
1440504	MDP3141
1617343	MDP3087K
1617343	MAX087K
1617343	MDP9000
1628064	MDP3126K
1628064	MAX126K
1962433	MDP3244K
1962433	MDP3246K
AMPA694	MDP3077
BBU8177	MDP3017
BBU8177	MDP3077

CROSS REFERENCE TO MERITOR BRAKE PADS

FREIGHTLINER	MERITOR
976003	MDP3087K
976003	MAX087K

FRUEHAUF	MERITOR
M910001-01	MDP9002
M910045-02	MDP9000

HVE SOUTHERN CROSS	MERITOR
FB4450	MDP3165K
FB4450A	MDP3095K
FB4640	MDP3167K
FB4642	MDP3169K
FB4644	MDP3171K
FB4648	MDP3087K
FB4652	MDP3174K
FB4653	MDP3088K
FB4654	MDP3090K
FB4671	MAX087K
FB4675	MDP3125K
FB4677	MDP3131K
FB4678K	MDP3141
FB4679	MDP3142
FB4680	MDP3143K
FB4683	MDP3162K
FB4684K	MDP3030K
FB4690	MDP3124K
FB4691	MDP3126K

IVECO	MERITOR
1903486	MDP3017
01906043	MDP2004
1906070	MDP3024
1906144	MDP2012
1906146	MDP2004
1906170	MDP3032K
1906183	MDP2022
1906191	MDP3011K
1906297	MDP2004
1906297	MDP5453
1906298	MDP2012
1906345	MDP3017
1906401	MDP2003
1906401	MDP2018
1906416	MDP3122
1906427	MDP2022
1906459	MDP3011K
1906467	MDP3088K
1906467	MAX088K
2992336	MDP3095K
2992336	MAX095K
2992339	MDP2003
2992339	MDP2018
2992348	MDP3087K

IVECO	MERITOR
2992348	MAX087K
2992476	MDP3087K
2992476	MAX087K
2992479	MDP3011K
2996468	MDP3095K
2996468	MAX095K
4856911	MDP3032K
4856912	MDP3011K
7173317	MDP3011K
41211278	MDP3087K
41211278	MAX087K
42470841	MDP1405
42535791	MDP2003
42535791	MDP2018
42555406	MDP1405
42555669	MDP3122
42560080	MDP1405
42561102	MDP1405
8285388435	MDP3030K
8285388435	MAX030K
8285388533	MDP3030K
8285388533	MAX030K
8285408463	MDP3030K
8285408463	MAX030K
8285408534	MDP3030K
8285408534	MAX030K
8285515573	MDP3087K
8285515573	MAX087K
8285521000	MDP3030K
8285521000	MAX030K
8285522000	MDP3030K
8285522000	MAX030K
8285525000	MDP3030K
8285525000	MAX030K
8285526000	MDP3030K
8285526000	MAX030K
2992336	MDP9002
2996515	MDP9000

KASSBOHRER	MERITOR
81508206000	MDP3030K
81508206000	MAX030K
81508206002	MDP3030K
81508206002	MAX030K
81508206002	MDP5038
81508206004	MDP3030K
81508206004	MAX030K
81508206004	MDP5038
81508206006	MDP3088K
81508206006	MAX088K
81508206014	MDP3030K
81508206014	MAX030K

CROSS REFERENCE TO MERITOR BRAKE PADS

KASSBOHRER	MERITOR
81508206014	MDP5038
81508206016	MDP3030K
81508206016	MAX030K
81508206016	MDP5038
81508206020	MDP3088K
81508206020	MAX088K
81508206025	MDP3030K
81508206025	MAX030K
81508206030	MDP3087K
81508206030	MAX087K
81508206030	MDP9001
81508206032	MDP3087K
81508206032	MAX087K
81508206033	MDP3087K
81508206033	MAX087K
81508206034	MDP5038
81508206036	MDP3030K
81508206036	MAX030K
81508206041	MDP3131K
81508206041	MAX131K
81508206041	MDP5073
81508206042	MDP3093
81508206043	MDP3148K
81508206044	MDP3030K
81508206044	MAX030K
81508206046	MDP3030K
81508206046	MAX030K
81508206046	MDP5038

KNORR	MERITOR
K070796	MDP3171K
K070796	MAX171K

MAN	MERITOR
81508080003	MDP5038
81508205006	MDP3030K
81508205006	MAX030K
81508205020	MDP3030K
81508205020	MAX030K
81508205023	MDP3088K
81508205023	MAX088K
81508205025	MDP3088K
81508205025	MAX088K
81508205029	MDP3088K
81508205029	MAX088K
81508205040	MDP3030K
81508205040	MAX030K
81508205047	MDP3030K
81508205047	MAX030K
81508205060	MDP3030K
81508205060	MAX030K
81508205064	MDP3030K

MAN	MERITOR
81508205064	MAX030K
81508205066	MDP3030K
81508205066	MAX030K
81508205068	MDP3030K
81508205068	MAX030K
81508205072	MDP3131K
81508205072	MAX131K
81508205072	MDP5073
81508205078	MDP3030K
81508205078	MAX030K
81508205080	MDP3131K
81508205080	MAX131K
81508205080	MDP5073
81508205085	MDP3148K
81508205087	MDP3030K
81508205087	MAX030K
81508205091	MDP3030K
81508205091	MAX030K
81508205091	MDP5038
81508205098	MDP9002
81508205099	MDP9000
81508206051	MDP3131K
81508206051	MAX131K
81508206051	MDP5073
81508206055	MDP3087K
81508206055	MAX087K
81508206056	MDP3087K
81508206056	MAX087K
81508206056	MDP9002
81508206059	MDP9002

MERCEDES BENZ	MERITOR
0004209720	MDP1306
0004210510	MDP3087K
0004210510	MAX087K
0004210510	MDP9000
0004210710	MDP3095K
0004210710	MAX095K
0004210810	MDP9002
0004211010	MDP3148K
0004211210	MDP3148K
0004211810	MDP9001
0004212410	MDP1039
0004214310	MDP3087K
0004214310	MAX087K
0004214310	MDP9002
0004215010	MDP9002
0004215110	MDP9003
0004236610	MDP9003
0014201520	MDP3835K
0014210510	MDP3148K
0014210610	MDP3148K

CROSS REFERENCE TO MERITOR BRAKE PADS

MERCEDES BENZ	MERITOR
0014211710	MDP3095K
0014211710	MAX095K
0014212510	MDP3148K
0014212610	MDP3148K
0024200820	MDP3030K
0024200820	MAX030K
0024203820	MDP1039
0024203920	MDP1038
0024204920	MDP3087K
0024204920	MAX087K
0024204920	MDP9004
0024205520	MDP3030K
0024205520	MAX030K
0024205620	MDP1039
0024205720	MDP3835K
0024206220	MDP3835K
0024206920	MDP1039
0024207020	MDP9005
0024207820	MDP3095K
0024207820	MAX095K
0024207820	MDP9002
0024207920	MDP3095K
0024207920	MAX095K
0024209920	MDP1038
0034201020	MDP9006
0034201120	MDP3148K
0034201220	MDP3148K
0034201520	MDP3835K
0034201620	MDP3087K
0034201620	MAX087K
0034201620	MDP9007
0034202020	MDP3087K
0034202020	MAX087K
0034202020	MDP9008
0034202220	MDP3087K
0034202220	MAX087K
0034202220	MDP9009
0034202420	MDP1306
0034202420	MDP1306
0034203520	MDP9010
0034203520	MDP3087K
0034203520	MAX087K
0034204420	MDP3835K
0034206620	MDP3148K
0034207220	MDP3148K
0034207320	MDP3148K
0034207720	MDP3835K
0044202220	MDP3087K
0044202220	MAX087K
0044202220	MDP9011
0044202520	MDP1306

MERCEDES BENZ	MERITOR
0044204820	MDP3835K
0044205520	MDP1038
0044206020	MDP9012
0054202320	MDP3095K
0054202320	MAX095K
002420222010	MDP3087K
002420222010	MAX087K
81508206060	MDP9002
0064201520	MDP3244K
A0002420702	MDP3087K
A0004211810	MDP3087K
A0004236610	MDP3087K
A0034201020	MDP3087K
A0064201520	MDP3246K

NEOPLAN	MERITOR
082135100	MDP3087K
082135100	MAX087K

RENAULT	MERITOR
5001014694	MDP2012
5001014704	MDP2004
5001014704	MDP5453
5001823000	MDP3030K
5001823000	MAX030K
5001825638	MDP2012
5001825639	MDP2004
5001825639	MDP5453
5001844747	MDP2003
5001844747	MDP2018
5001846034	MDP3090K
5001846034	MAX090K
5001850859	MDP2003
5001850859	MDP2018
5001855646	MDP3131K
5001855646	MAX131K
5001855646	MDP5073
5001855902	MDP3142
5001864363	MDP5101
5001864363	MDP3174K
5001864363	MAX174K
5001864364	MDP5101
6694200020	MDP3835K
6694200120	MDP3835K
6704202820	MDP3835K
500 182 30 00	MDP3030K
500 182 30 00	MAX030K
901 421 04 10	MDP1038
901 421 05 10	MDP1038
901 421 06 10	MDP1038
A0034202420	MDP1306

CROSS REFERENCE TO MERITOR BRAKE PADS

ROR	MERITOR
68324665	MDP5093
15227419T	MDP3131K
15227419T	MAX131K
15227419T	MDP5073
MDP1314	MDP5076
MDP5076	MDP5076
MDP5093	MDP3169K
MDP5093	MDP5093

SAE	MERITOR
09317202	MDP9001
9317202	MDP9001
09317330	MDP9003
9317330	MDP9003

SAF	MERITOR
12182192	MDP3126K
12182192	MAX126K
12182492	MDP3126K
12182492	MAX126K
12999737	MDP3126K
12999737	MAX126K
233501309	MDP3162K
3057007700	MDP3087K
3057007700	MAX087K
3057007700	MDP9001
3057007800	MDP3095K
3057007800	MAX095K
3057007800	MDP9003
3057007900	MDP3087K
3057007900	MAX087K
3057008000	MDP3126K
3057008000	MAX126K
3057008400	MDP3162K
4057427700	MDP9001
4057427800	MDP9003
5001864364	MDP3174K
5001864364	MAX174K
5001864365	MDP5102
5001864365	MDP3173K
5001864365	MAX173K
5001864380	MDP3169K
5001864380	MDP5093
5010848607	MDP3088K
5010848607	MAX088K
5317002300	MDP3087K
5317002300	MAX087K
5317002300	MDP9001
5317002400	MDP3095K
5317002400	MAX095K
5317002400	MDP9003
7421399915	MDP5102

SAF	MERITOR
7421399915	MDP3173K
7421399915	MAX173K

SCANIA	MERITOR
2325212	MDP3087K
139 04 28	MDP9000
173 45 29	MDP9000
185 61 08	MDP9000
189 08 61	MDP9000
1390428	MDP3087K
1390428	MAX087K
1521979	MDP3087K
1521979	MAX087K
1527633	MDP3087K
2217804	MDP3087K

TEXTAR	MERITOR
2903009	MAX030K
2903009	MDP3030K
2908711	MAX087K
2908711	MDP3087K
2909006	MAX090K
2909006	MDP3090K
2913103	MAX131K
2913103	MDP3131K
2917301	MAX173K
2917301	MDP3173K
2917401	MAX174K
2917401	MDP3174K
2924401	MAX244K
2924401	MDP3244K
2924601	MAX246K
2924601	MDP3246K
2927701	MAX125K
2927701	MDP3125K
2928501	MAX088K
2928501	MDP3088K
2930601	MAX165K
2930601	MDP3165K
2930701	MAX167K
2930701	MDP3167K
2930801	MAX171K
2930801	MDP3171K
2931301	MAX126K
2931301	MDP3126K
2932001	MAX095K
2932001	MDP3095K
2933601	MAX162K
2933601	MDP3162K

CROSS REFERENCE TO MERITOR BRAKE PADS

TRP	MERITOR
908134	MDP3087K
908134	MAX087K
908137	MDPDX195
908137	MDP3124K
908138	MDP3126K
908138	MAX126K
908142	MDP3095K
908142	MAX095K
1536932	KIT225020
1536934	MMD1369AF
1536935	MDPEX225
1540192	MDP3087K
1540192	MAX087K
1961734	MDP3165K
1961734	MAX165K
1961736	MDP3171K
1961736	MAX171K
1962267	MDP3174K
1962267	MAX174K
1962431	MDP3171K
1962431	MAX171K
1962432	MDP3162K
1962432	MAX162K
1962436	MDP3228K

VOLVO	MERITOR
3093531	MDP3136K
3093531	MDP5052
3093532	MDP3137K
3093532	MDP5053
3093919	MDP3090K
3093919	MAX090K
3095396	MDP3125K
3095396	MAX125K
3095396	MDP5057
3903532	MDP5053
20526568	MDP5104
20526568	MDP3174K
20526568	MAX174K
20560412	MDP5104
20560412	MDP3174K
20560412	MAX174K
20568711	MDP5104
20568711	MDP3174K
20568711	MAX174K
20568712	MDP3173K
20568712	MAX173K
20568712	MDP5106
20568713	MDP3169K
20568713	MDP5093
20765963	MDP3169K

VOLVO	MERITOR
20765963	MDP5093
20768092	MDP3125K
20768092	MAX125K
20768092	MDP5057
20768115	MDP3137K
20918891	MDP3125K
20918891	MAX125K
20918891	MDP5057
20931343	MDP3125K
20931343	MAX125K
20931343	MDP5057
20932682	MDP3125K
20932682	MAX125K
20932682	MDP5057
21204702	MDP3174K
23149532	MDP3174K
85506111	MDP3090K
85506111	MAX090K
231496550	MDP3174K

VW	MERITOR
2D0698151	MDP1038
2D0698151C	MDP1038
2D0698451A	MDP1039
2D0698451B	MDP1306
2D0698451G	MDP1306

VVA	MERITOR
21576	MDP1038
21592	MDP1405
21621	MDP1039
23021	MDP1306
29001	MDP2022
29011	MDP3011K
29017	MDP3017
29024	MDP3024
29030	MDP3030K
29030	MAX030K
29030	MDP5038
29032	MDP3032K
29042	MDP3087K
29061	MDP3087K
29061	MDP9000
29061	MDP9001
29065	MDP2012
29067	MDP2004
29077	MDP3077
29087	MDP3087K
29087	MAX087K
29087	MDP9000

CROSS REFERENCE TO MERITOR BRAKE PADS

WVA	MERITOR
29087	MDP9001
29088	MDP3088K
29088	MAX088K
29090	MDP3090K
29090	MAX090K
29093	MDP3095K
29094	MDP3095K
29095	MDP3095K
29095	MAX095K
29096	MDP3095K
29106	MDP3087K
29108	MDP3087K
29109	MDP3087K
29121	MDP2003
29121	MDP2018
29122	MDP3122
29124	MDP3124K
29124	MDP5076
29125	MDP3125K
29125	MAX125K
29125	MDP5057
29126	MDP3126K
29126	MAX126K
29126	12999737VT
29131	MDP3131K
29131	MAX131K
29131	MDP5073
29136	MDP3136K
29136	MDP5052
29137	MDP3137K
29137	MDP5053
29141	MDP3141
29142	MDP3142
29145	MDP3095K
29148	MDP3148K
29159	MDP3126K
29159	12999737VT
29162	MDP3162K
29162	MAX162K
29162	12999796
29163	MDP3087K
29165	MDP3165K
29165	MAX165K
29167	MDP3167K
29167	MAX167K
29169	MDP3169K
29169	MDP5093
29171	MDP3171K
29171	MAX171K
29173	MDP3173K
29173	MAX173K

WVA	MERITOR
29173	MDP5102
29173	MDP5106
29174	MDP3174K
29174	MAX174K
29174	MDP5101
29179	MDP3087K
29184	MDP3095K
29197	MDP3095K
29197	MDP9002
29197	MDP9003
29202	MDP3087K
29228	MDP3228K
29244	MDP3244K
29244	MAX244K
29246	MDP3246K
29246	MAX246K
29302	MDP5453

CROSS REFERENCE TO MERITOR BRAKE ROTORS

ATAP	MERITOR
CDR1000	MBR2649
CDR1001	MBR5001
CDR1002	MBR5063
CDR1003	MBR5011
CDR1004	MBR5010
CDR1005	MBR5014
CDR1007	MBR5016HD
CDR1008	MBR1588
CDR1009	MBR5039
CDR1010	MBR5110
CDR1011	MBR5805
CDR1014	MBR2711
CDR1015	MBR5113
CDR1016	MBR5077
CDR1017	MBR5071
CDR1018	MBR5003
CDR1019	MBR5013
CDR1020	MBR5012
CDR1022	MBR5075
CDR1023	MBR5006
CDR1024	MBR5061
CDR1025	MBR5073
CDR1025	MBR9018
CDR1028	MBR5002
CDR1029	MBR5025
CDR1031	MBR5072
CDR1032	MBR6026
CDR1033	MBR5062
CDR1034	MBR5107
CDR1036	MBR2648
CDR1038	MBR5079
CDR1038	MBR9014
CDR1039	MBR5056
CDR1040	MBR5801
CDR1041	MBR5047
CDR1042	MBR5105
CDR1043	MBR9018
CDR1043	MBR9018
CDR1044	MBR6036
CDR1045	23123615002
CDR1046	MBR5803
CDR1050	MBR6029
CDR1051	M44D802081
CDR1052	MBR5116
CDR1053	M44D802082
CDR1057	MBR5104
CDR1058	MBR5106
CDR1060	MBR6028
CDR1061	3218N1366
CDR1063	MBR5115
CDR1065	MBR5806*

ATAP	MERITOR
CDR1066	MBR5015
CDR1067	MBR5128
CDR1068	MBR5068
CDR1069	MBR5108
CDR1070	MBR5057
CDR1071	MBR5075
CDR1073	M44DH85621
CDR1075	MBR5802
CDR1103	MBR9015

BENDIX	MERITOR
802081	M44D76618
802082	M44D76617

BERKOF	MERITOR
1402272	MBR5025

BPW	MERITOR
0308835057	MBR5105
2991646	MBR6006
2991979	MBR2711
2992271	MBR5116
2992291	MBR6026
2992470	MBR5063
2992477	MBR6036
2992636	MBR6028
2995894	MBR6029
2996327	MBR6036
2996328	MBR6037
4247111	MBR6010
7172018	MBR2649
0300224093	MBR5061
0308834017	MBR5047
0308834020	MBR5061
0308834030	MBR5062
0308834037	MBR5062
0308834040	MBR5061
0308834047	MBR5061
0308834050	MBR5105
0308834057	MBR5105
0308834060	MBR5061
0308834070	MBR5113
0308834071	MBR5113
0308835010	MBR5047
0308835050	MBR5105
0308835060	MBR5803

DAF	MERITOR
1792411111131	MBR5003
AMPB887	MBR5006
MAK2487	MBR5006
PA3546	MBR5006

*Requires installation KIT5806

CROSS REFERENCE TO MERITOR BRAKE ROTORS

FUWA KHITCH	MERITOR
7978731901	MBR5805
820105	MBR5805

HENDRICKSON	MERITOR
98815-011	MBR5801
98815-018	MBR5802
98815-019	MBR5830

HVE SOUTHERN CROSS	MERITOR
AP3200	MBR5113
AP3202	MBR5062
AP3203	MBR5047
AP3204	MBR5803
AP3207	MBR5105
AP3209	MBR5031
AP3210	MBR5072
AP3212	MBR5061
AP3214	MBR5803
AP3215	MBR5801
AP3217	MBR6026
AP3218	MBR6036
AP3220	16160001001
AP3221	3218N1366
AP3222	MBR5014
AP3223	MBR5057
AP3228	MBR5079
AP3232	23123615002
AP3235	MBR5804
AP3262	MBR5025
AP3264	MBR5016HD

IVECO	MERITOR
1906438	MBR5063
1906461	MBR5063
1907526	MBR2649
1907527	MBR2649
1907530	MBR2649
1907569	MBR5001
1907631	MBR2711
1907726	MBR2649
1908578	MBR2649
1908614	MBR2711
1908729	MBR2711
1908772	MBR6009
1908773	MBR6010
1908793	MBR6010
7172928	MBR5001
7172929	MBR5001
7172930	MBR5001
7173317	MBR2711
7179778	MBR5063
7180111	MBR2711

IVECO	MERITOR
7180256	MBR6010
7182299	MBR6006
7182300	MBR6007
7182305	MBR5063
7182682	MBR2649
7183775	MBR5116
7183804	MBR5116
42470836	MBR6005
42470842	MBR6009
42471034	MBR6007
42471111	MBR6010
93821918	MBR6009
500306590	MBR6005
1139098F	MBR2711

KASSBOHRER	MERITOR
924111113	MBR5003
8284000047	MBR5110
8284000147	MBR5110
8284000208	MBR5003
17924111111	MBR5003
17924111130	MBR5110
179241111131	MBR5003
179241111307	MBR5110
1792411111310	MBR5003
1792411113070	MBR5110
179241111131B	MBR5003
11350103	MBR5110
11351605	MBR5003

MAN	MERITOR
9754230312	MBR5071
81508030020	MBR5014
81508030021	MBR5068
81508030022	MBR5013
81508030023	MBR5057
81508030027	MBR5014
81508030031	MBR5057
81508030038	MBR5057
81508030040	MBR5057
81508030041	MBR5068
81508030042	MBR5068
81508030046	MBR5057
81508030047	MBR5068
81508030053	MBR5068
81508030057	MBR5014
81508030061	MBR5013

CROSS REFERENCE TO MERITOR BRAKE ROTORS

MERCEDES BENZ	MERITOR
955952	MBR5075
6684210512	MBR5075
6684230512	MBR5075
9014210312	MBR6011
9014210612	MBR6011
9024210312	MBR6011
9024210612	MBR6011
9024210712	MBR6011
9024210912	MBR6011
9024230112	MBR6012
9024230312	MBR6012
9024234312	MBR6012
9044230212	MBR6013
9044230312	MBR6013
9424212112	MBR5016HD
9434210312	MBR5128
9754120112	MBR5077
9754210012	MBR5077
9754210112	MBR5077
9754210212	MBR5077
9754219112	MBR5077
9754230012	MBR5071
9754230312	MBR5071
9754230612	MBR5071
902421091204	MBR6011
2D0615301A	MBR6011
2D0615301B	MBR6011
A9424230112	MBR5016HD

MERITOR	MERITOR
21224263	MBR5079
68323825	MBR5124
68325372	MBR9014
68326552	MBR5124
83253731	MBR9014
663253731	MBR5808
3218H1308	MBR5079
MBR9004	MBR5124
MBR9017	MBR5079

NEOPLAN	MERITOR
9754210112	MBR5077
9754230312	MBR5071
9755420012	MBR5071

LEYLAND - DAF	MERITOR
MAK2487	MBR5006
PAK3546	MBR5006

RENAULT	MERITOR
3092710	MBR9000
8551042	MBR9000
5001864498	MBR9000
5010260218	MBR5107
5010422263	MBR5112

ROCKWELL	MERITOR
68323825	MBR5124
68323825	MBR9004
MBR9004	MBR5124

ROR	MERITOR
21224263	MBR5079
21227349	MBR5073
68323825	MBR5124

RVI	MERITOR
504134958	MBR5056
4079000300	MBR5074
4079000301	MBR5074
4079000400	MBR5072
4079000700	MBR5059
4079000701	MBR5059
4079001300	MBR5125
4079001301	MBR5125
5006172150	MBR5056
5010216437	MBR5056
5010422363	MBR5056
5010422593	MBR5056
5010525362	MBR5115
50100525015	MBR5115
4079000701A	MBR5059

SAF	MERITOR
4079901201	MBR5804
4079001204	MBR5804
4079001400	MBR5807

SAURER	MERITOR
4079000300	MBR5074
4079000301	MBR5074

SCANIA	MERITOR
1386686	MBR5025
1402272	MBR5025
1852817	MBR5025
14022272	MBR5025
CVD553	MBR5025
K000510	MBR5025

SETRA	MERITOR
351605	MBR5003
4940065	MBR5110
924111113	MBR5003
8284000147	MBR5110
17924111307	MBR5110
179241111131	MBR5003
1792411111310	MBR5003
1792411113070	MBR5110
179241111131B	MBR5003
17924111113B	MBR5003
11350103	MBR5110
11351605	MBR5003

CROSS REFERENCE TO MERITOR BRAKE ROTORS

TRP	MERITOR
TRPDR001	MBR5803
TRPDR002	3218N1366
TRPDR004	MBR5113
TRPDR006	23123642002
TRPDR007	MBR5804
TRPDR008	23123615002

VANHOOL	MERITOR
1402272	MBR5025
68323232	MBR9000

VOLVO	MERITOR
3095652	MBR9002
3095653	MBR9003
3095672	MBR9000
3112965	MBR5108
68323210	MBR9003
68323231	MBR9002
8551042	MBR5806*
85103809	MBR5806*
1625040128	MBR5806*
3092710	MBR5806*
20995144	MBR9013

VW	MERITOR
2D0615301B	MBR6011
2D0615301C	MBR6011
2D0615601A	MBR6012
2D0615601B	MBR6013

WATTS	MERITOR
MDC1438	MBR6005
MDC1439	MBR6006
MDC1440	MBR6007
MDC994	MBR6009
MDC995	MBR6010
WDR516	MBR5001
WDR519	MBR2711
WDR524	MBR2649
WDR536	MBR5013
WDR543	MBR5014
WDR552	MBR5016HD
WDR553	MBR5025
WDR555	MBR5047
WDR556	MBR5063
WDR561	MBR5061
WDR564	MBR5042
WDR566	MBR5073
WDR566	MBR9018
WDR575	MBR5074
WDR579	MBR5057
WDR587	MBR5113
WDR596	MBR5075
WDR606	MBR5056
WDR610	MBR5108
WDR611	MBR60101
WDR612	MBR5068
WDR700	MBR5801
WDR701	MBR5802

WATTS	MERITOR
WDR703	MBR5803
WDR704	MBR5804
WDR705	MBR5805
WDR706	MBR9015
WDR707	MBR5128
WDR710	MBR5116
WDR711	MBR6026
WDR712	MBR6025
WDR713	MBR6008
WDR715	MBR5079
WDR715	MBR9014
WDR716	MBR5072
WDR718	MBR5125
WDR719	MBR5806*
WDR720	MBR6029
WDR721	MBR9000
WDR729	23123615002
WDR586	MBR5062
WDR587	MBR5113
WDR616	MBR5105
WDR608	MBR5032
WDR616	MBR5105
WDR700	MBR5801
WDR726	M44D802081
WDR730	MBR5830

*Requires installation KIT5806

BRAKE PADS & ROTORS PAIRING GUIDE

TRADE NO.	PAD NO.	CALIPER NO.	COMPARABLE NO.		ROTOR NO.	OE	MAKE OR AXLE	COMPARABLE NO.
29171	MDP3171K MAX171K	KNORR SK7000 / SB4309 BENDIX ADB225	WDP094K	➔	MBR5803	0308835060	BPW	
					M44D802082 M44D802081	802082 802081	WESTAR WESTAR	WDR703
29126	MDP3126K MAX126K	WABCO PAN 19-1	WDP090K	➔	MBR5805	7978731901	FUWA KHITCH	WDR705
					MBR5072	4079000400	SAF	WDR716
					MBR5804	4079901201	SAF	WDR704
29087	MDP3087K MAX087K	KNORR SB7000	WDP020K	➔	MBR5801	98815011/6	HENDRICKSON	WDR700
					MBR5802	98815018	HENDRICKSON	WDR701
					M44D802669	802669	DENNIS EAGLE	
					MBR5074	4079000300	SAF	WDR575
					MBR5025	1402272	SCANIA	WDR553
					MBR5016HD	9424212112	MERCEDES BENZ	WDR552
					MBR5056	5010422363	MACK / RENAULT	WDR606
					MBR5063	1906461	IVECO	WDR556
					MBR2711	1906191	IVECO	WDR519
					MBR6036	2996327	IVECO	2996327
MBR5047	0308835010	BPW	WDR555					
29174	MDP3174K MAX174K	MERITOR ELSA 225-3	CV0101K	➔	MBR5806	8551042	VOLVO	WDR719
26169	MDP3169K	MERITOR ELSA 195	29169	➔	MBR5079	21224263	MERITOR / ROR	WDR715
29095	MDP3095K MAX095K	KNORR SB6000	WDP036K	➔	MBR5113	03.088.34.07.0	BPW	WDR587
					MBR5061	0308834047	BPW	WDR561
					MBR6026	2992291	IVECO	WDR711
					MBR6029	2995894	IVECO	WDR720
					MBR6028	2992636	IVECO	CDR1060
					MBR5014	81508030027	MAN	WDR543
					MBR5077	9754210212	MERCEDES BENZ	CDR1016
					MBR5071	9754230612	MERCEDES BENZ	WDR560
29125	MDP3125K MAX125K	MERITOR D DUCO	29125		MBR5124	68323825	MERITOR / ROR	MBR9004
29131	MDP3131K MAX131K	MERITOR ELSA 2	WDP088K	➔	MBR5056	5010422363	MACK / RENAULT	WDR606
					MBR5057	81508030040	MAN	WDR579
					MBR5068	81508030021	MAN	WDR544
29124	MDP3124K	MERITOR DX195	WDP024K	➔	MBR5073	21227349	MERITOR / ROR	WDR566
					MBR5079	21224263	MERITOR / ROR	WDR715
29162	MDP3162K MAX162K	WABCO PAN 22-1	WDP096K	➔	MBR5125	4079001301	SAF	WDR718



**ASK FOR MERITOR ROTORS
WHEN REPLACING YOUR MERITOR BRAKE PADS**

**AND GET THE BEST ENGINEERED BRAKE
PERFORMANCE**



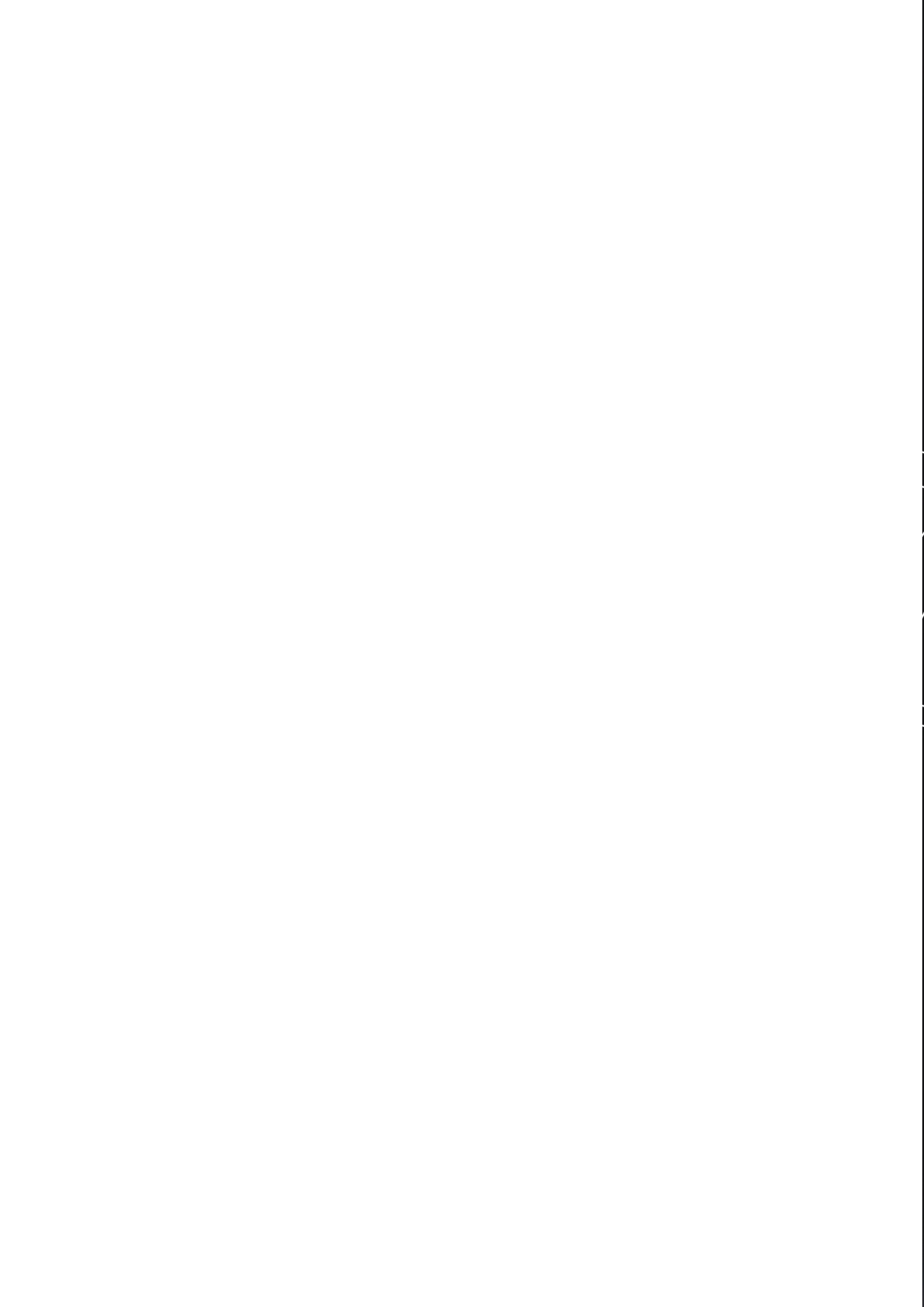



Meritor Heavy Vehicle Systems
50 Calarco Drive
Derrimut Vic 3026 Australia

Phone: (+61 3) 8353 6050
Email: cvaa.sales@meritor.com
Website: meritorpartsonline.com.au

©2021 Meritor, Inc.
Australia, CAT011
Issued 10-21